

Powerhouse Pro 10 Amp System Reference Manual

**Copyright 1994-2000
NCE Corporation
1260 Creek Street Suite100
Webster, NY 14580**

About NCE

NCE has been manufacturing DCC products on an OEM basis since 1993. Originally we offered only “chip sets” that contained software enabling other DCC manufacturers to build DCC systems. As time went on some of those manufacturers asked us to first supply partial assemblies then complete assemblies in addition to the chip sets. This has helped NCE to grow into a full time electronic design and manufacturing firm devoted entirely to the development and sale of products for the control of model railroads. We build an amazing array of products for both our own customers and other DCC manufacturers. We keep labor costs low by utilizing modern automated robotic assembly for most products. Recently we have more than doubled our manufacturing space.

Our product designer is Jim Scorse. Jim models the Erie Railroad in O-Scale and has a long history in model railroading. He has numerous patents in the area of imagery, video and computer network data communications over noisy channels. Jim is active in the Layout Design SIG as well as 27 years with the “Tuesday Night Gang”, (round robin model railroad club) and is probably one of the only really active model railroaders among all the DCC manufacturers.

PREFACE

This manual covers the installation, programming and operation of the NCE Powerhouse Pro-10 DCC system. It is not a comprehensive tutorial on all the aspects of Digital Command Control. Although it is not necessary to know the inner workings of DCC there are some users that may wish to delve deeper into the how and why of digital packet transmission for model railroad control. Especially those wishing to use the computer interface on the Powerhouse Pro. For those interested in the “nuts and bolts” we recommend the reading of the following NMRA Standards and Recommended Practices as they pertain to DCC. Applicable standards are: S-9, S9.1 and S-9.2 and Recommended Practices: RP-9.1.1 through RP-9.2.4. These documents are available via the Internet at www.nmra.org or by mail from the NMRA headquarters in Chattanooga, Tennessee.

TABLE OF CONTENTS

WARRANTY INFORMATION.....	5
REGISTER MY SYSTEM... WHY?.....	6
QUICK START.....	6
UNPACKING YOUR SYSTEM.....	6
CONNECTING THE COMPONENTS.....	7
CHART OF COMMON MOTOR STALL CURRENTS.....	8
INSTALLING THE DECODER.....	8
PROGRAMMING THE DECODER.....	9
RUNNING YOUR FIRST DCC LOCO.....	9
GENERAL SYSTEM INSTALLATION.....	11
DEVICE LOCATIONS.....	11
POWER REQUIREMENTS.....	11
PROGRAMMING TRACK.....	11
REVERSE BLOCKS, WYES, AND CROSSOVERS.....	12
WIRING.....	12
SYSTEM EQUIPMENT DESCRIPTIONS.....	13
THE POWERHOUSE CS02 COMMAND STATION.....	13
COMMAND STATION CONNECTIONS AND INDICATORS.....	13
COMPUTER INTERFACE PORT.....	14
REPLACING THE EPROM IN YOUR POWERHOUSE-PRO:.....	15
CONFIGURATION JUMPERS.....	16
ANALOG LOCOMOTIVE CONTROL.....	17
PB110A POWER BOOSTER.....	19
CONNECTIONS, CONTROLS and INDICATORS.....	19
WIRING TO A DIGITRAX SYSTEM.....	23
THE PRO CAB.....	25
THE LCD SCREEN.....	25
LOCOMOTIVE CONTROL AREA.....	26
COMMONLY USED BUTTONS.....	27
LOCO and ACCESSORY SELECTION GROUP.....	28
DATA ENTRY/FUNCTION CONTROL.....	29
CONSIST SETUP GROUP.....	29
PROGRAMMING and EXTENDED FUNCTION CONTROL.....	30
CAB SETUP.....	31
CAB BUTTON NUMBERING SCHEME.....	34
TABLE OF FACTORY DEFAULT VALUES.....	35
PROCAB SPECIFICATIONS:.....	36
6 WIRE CAB BUS CABLE WITH RJ-12 CONNECTORS.....	36
RJ-12 TO 3 WIRE PHONE PLUG CABLE.....	36
DECODERS.....	37
PRECAUTIONARY INSTALLATION NOTES.....	37
DECODER INSTALLATION.....	37
OPERATING PROCEDURES.....	40
THE "NORMAL" DISPLAY.....	40
SELECTING A LOCOMOTIVE OR CONSIST.....	41
CONTROLLING HEADLIGHTS AND OTHER DECODER FUNCTIONS.....	42
CONSISTS - OLD AND ADVANCED CONSISTS EXPLAINED.....	43

ADVANCED.....	43
OLD STYLE (also called brute force or Universal consistng).....	43
SETTING UP AN ADVANCED CONSIST	44
ADDING A LOCO TO AN ADVANCED CONSIST	46
DROPPING A LOCOMOTIVE FROM AN ADVANCED CONSIST.....	46
CLEARING AN ADVANCED CONSIST	47
CHANGING THE LEAD LOCO.....	47
OLD STYLE CONSISTS.....	48
SETUP AN OLD STYLE CONSIST	48
SCREEN DISPLAYED WHEN OPERATING OLD STYLE CONSISTS.....	49
ADDING A LOCO TO AN OLD STYLE CONSIST	49
DROPPING A LOCO FROM AN OLD STYLE CONSIST	50
CLEARING AN OLD STYLE CONSIST	51
CONTROLLING TURNOUTS AND OTHER ACCESSORIES.....	51
USE MACROS TO CONTROL TURNOUTS.....	52
MACROS EXPLAINED	52
HELPFUL HINTS FOR OPERATION	53
PROGRAMMING PROCEDURES	56
PROGRAM MODE SCREENS EXPLAINED.....	56
PROGRAMMING ON THE MAIN.....	59
WHAT TO PROGRAM	59
CONSIST PROGRAMMING (option 1)	59
CV PROGRAMMING (Option 2).....	60
SET DECODER CONFIGURATION (option 3)	61
PROGRAMMING A LOCO ADDRESS ON THE MAINLINE.....	62
ASSIGNING A LOCO TO A CAB	63
SET THE SYSTEM CLOCK.....	63
USE PROGRAM TRACK	65
SELECTING PROGRAMMING METHOD.....	65
STANDARD PROGRAMMING (Option 1)	65
SETTING THE DECODER CONFIGURATION (CFG).....	67
CV PROGRAMMING (option 2).....	68
REGISTER PROGRAMMING (Option 3)	69
RESET DECODERS TO FACTORY VALUES (Option 4).....	70
SPEED TABLE PROGRAMMING (option 5)	70
SETUP COMMAND STATION	71
DISPLAY SOFTWARE VERSION AND DATE.....	71
SETTING THE CAB PARAMETERS	75
PROGRAM ACCESSORY DECODERS ON THE MAIN	78
PROGRAM MACROS.....	79
RS232 SERIAL COMPUTER INTERFACE.....	81
CABLE	81
COMMUNICATIONS PARAMETERS	81
ASCII COMMAND SET	82
PROGRAMMING MODE COMMANDS.....	90
BINARY COMMAND SET (recommended)	93
TROUBLE SHOOTING.....	100

CUSTOMER SERVICE

Customer Service is handled through our factory warranty center or through your dealer. It is faster to deal direct with the factory. Please write or call us before returning any products to our warranty center. Sometimes the problem is easily solved over the phone. If writing make sure you include your address and phone number and the times that you can be reached at that number. This will greatly expedite our service to you if you have questions.

NCE Corporation Attn. Warranty Center
1260 Creek Street Suite 105
Webster, NY 14580

Phone:..... 716-671-0370
Fax: 716-671-9337

E-Mail Address:.....support@ncedcc.com
Web Site:..... <http://www.ncedcc.com>

WARRANTY INFORMATION

We provide a 7 year warranty on all factory assembled products.

In the first three years full repair or replacement will be made to the original purchaser of any item that has failed due to manufacturer defect. Should the item no longer be produced and the item not repairable a similar item will be substituted at the manufacturer's discretion. The customer pays only shipping to the NCE Warranty Center. Please save your original receipt as a photocopy of it may be requested.

In years 4 to 7 a fair and reasonable service charge will be placed on each failed item returned for repair. Should the item no longer be produced and the item not repairable a similar item will be substituted at the manufacturer's discretion. The customer pays shipping to and from the NCE Warranty Center

This warranty is not valid if the customer has intentionally misused, miswired, performed any unauthorized alterations to the product or removed any product protection devices (such as heat shrink wrapping from decoders). In this case a service charge will be applied for all repairs and replacements . To protect the warranty please contact the Warranty Center for authorization prior to altering any product.

Please contact the Warranty Center for specific shipping instructions and any service charges before returning any product for service

We reserve the right to either repair or replace components sent to us for in-warranty service.

The warranty period will begin on the date shown on your retail sales receipt.

Please do not send anything for repair without first writing or calling to explain the problem. Also remember include your address and phone number with a brief description of the problem.

REGISTER MY SYSTEM... WHY?

By registering your Powerhouse Pro™ DCC system with us you will receive personal notification of any software and hardware up-dates. At various times we provide free updates to our customers at other times there is a nominal charge to cover shipping and handling (usually about \$5-\$6).

QUICK START

UNPACKING YOUR SYSTEM

All the devices and cables are included with the Powerhouse Pro 10 except the power supply transformers, which need to be purchased separately.

Recommended transformer: 18v at 10 amps or more Allied Electronics part number: 836-6155 (1-800-433-5700 MC/Visa)

Disconnect the existing power supplies from your layout.

We recommend that you follow the instructions below to connect your system to a small test track first. After your system is checked out completely and known to be working then consider the final installation locations for components and connections to the track.

CONNECTING THE COMPONENTS

- ✓ Set up a test track. Obtain a length or two of flex track, or better yet, use that old circle of prefab track you've had kicking around for years. Do *NOT* connect the Powerhouse up to your layout at this time. We want you to test the operation of your new DCC system without the complication of troubleshooting layout wiring, closed gaps, broken switch points, etc. Once you are confident that your new Powerhouse DCC system is up and running as advertised then hook it up to the layout (after finishing the Quick Start section). When you finally connect to your layout make sure that your layout wiring can stand a continuous 10 Amps of current. We recommend a minimum of #14 feeder bus, preferably #12 and at least #20 AWG power drops (not longer than 12 inches) from the rails to the feeder bus.
- ✓ Connect the 7 foot cable from the Command Station Cab Bus port to the Cab.
- ✓ Connect the 1 foot, 4 wire cable from the Command Station Control Bus port to the Power Station Control Bus port.
- ✓ Set the **MODE** Switch **UP** for normal layout running.
- ✓ Once you understand the features, and have operated a bit, you will be better able to determine the best way to divide up your layout into separate power districts (only if you need more power than one power station can provide).
- ✓ Provide power to both the Command Station and Power Station from your power supply transformer. Use fixed AC or DC only, not variable DC. **Note that the 10 Amp power station requires a minimum 16VAC at 12 Amps or more.** Failure to sufficient power may cause erratic power station operation under short circuit conditions eventually resulting in power station failure. Recommended transformer: 18v at 12 amps or more. Suppliers are Tony's Train Exchange model XFR/12 (1-800-978-7472 MC/Visa) or Allied Electronics part number: 836-6155 (1-800-433-5700 MC/Visa)
- ✓ Install the decoder in a locomotive (refer to the decoder installation section below). It is easier if just the track and motor wires are connected at this time. With O-Scale locomotives make sure the motor stall current does not exceed the ratings of your decoder. We recommend Weaver, Red Caboose or P&D plastic diesel locomotives for your first conversion in O-Scale. These locomotives have motors within the ratings of 4 Amp decoders. Older Laminated core motors such as K&D or some of the new motors installed in Overland Brass locomotives can draw as much as 12-14 Amps which will vaporize a 4 Amp decoder. We recommend re-motoring locomotives with a better quality lower current motor if you have some of these high current draw motors. Leave the shell off for now.

CHART OF COMMON MOTOR STALL CURRENTS

Motor	Stall Current (12 Volts DC)	Notes
Pittman 8514	8 Amps	Typical in older Weaver
Pittman 9512	4.7 Amps	
Pittman 9413	6 Amps	
Pittman 9414	8 Amps	Typical in Red Caboose
Pittman DC95	6 Amps	
CLW 1" stack	6 Amps	stack = lamination height
KTM 3x58	8.5 Amps	
KTM ¾" stack	6 Amps	stack = lamination height
KTM 1-3/16 stack	5.5 Amps	stack = lamination height
Weaver dual motor	8-10 Amps	
LGB - all	Usually less than 4 Amps	designed to use 18-20Volts
USA Trains	Usually less than 8 Amps GP9 is 30 AMPS!	Designed to use 12-16 volts
Deltron	Usually less than 10 Amps	

INSTALLING THE DECODER

Read the following section on decoders before starting. There are shortcuts to temporary installation of the other components, but do not shortcut the decoder. We recommend you get your first decoder installed by a dealer or locomotive manufacturer just so you have a good example of how it's done.

The most important part of a successful decoder installation is proper isolation of both motor brushes from the track so that they are driven only by the decoder. Failure to isolate will definitely damage the decoder. Damage caused by failure to isolate the motor is not be covered by the guarantee.

We find it preferable to mount the decoder with 1/2" wide 3M photo-mount double sided foam tape (we get ours at the local supermarket or Radio Shack).

Before test running your newly converted locomotive on full power double check your wiring to make sure the motor is fully isolated and that there are no pinched or broken wires. We see many decoders returned due to wires getting pinched between the body shell and frame causing shorts.

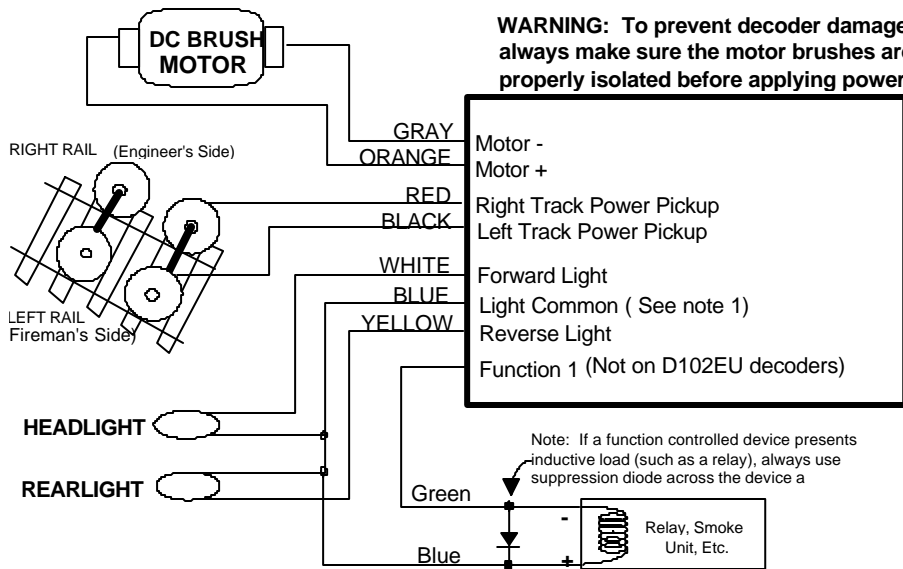

Note 1: The function common (blue wire) is the positive lead providing rectified DC voltage. If you elect to NOT use the common, power the light or other device from either track power pickup for "half-wave" operation (approx 1/2 voltage).

Due to the high in-rush current of incandescent grain-of-wheat type bulbs (about 10 times the normal operating current) we have rated the decoder function outputs at 100mA each. We recommend Miniaturics part number 18-014-10 (2.4mm diameter 14 volt/30mA) bulbs for good results. If you are running higher voltages (Power Station Scale switch set to ADJUST) you will need to use 18 volt bulbs.

If you need to use higher current lamps (50-150mA) we recommend a 22 ohm 1/4 Watt resistor in series with each bulb (this will also greatly extend bulb life). The function outputs are rated at 150mA continuous if used with LEDs or other low in-rush devices.

Always make sure the motor is isolated from the frame

Always make sure metal couplers are isolated from the frame

PROGRAMMING THE DECODER

All locomotive decoders come preset to the address of **3**. Programming should wait until after the loco is known to work properly. We normally test all new installations this way.

RUNNING YOUR FIRST DCC LOCO

Carefully inspect all wiring to make sure proper connections have been made. Do not permit unused decoder wires to touch each other. A piece of tape helps here.

Now double check all steps to be sure wiring is correct.

Plug in the power source and/or turn on the power. The display of the cab should show something like:

LOC:003	00:03AM
FWD:000	-----

This is what we call the '**NORMAL DISPLAY**'. The fast clock in the upper right hand corner will most likely show a different time.

The following cab buttons must be pressed in the proper sequence to acquire control of the locomotive #3 (in the above example locomotive #3 is already selected):

Press **SELECT LOCO** button once

Press the "**3**" button once. **DO NOT** press 0 then 3.

Press **ENTER**

TIP #1 → If you make a mistake while entering numbers on the cab just keep pressing more numbers until the number entry field clears, then enter the correct numbers.

TIP #2 → Whenever the cab is waiting for you to enter data (a flashing black square is on the screen at the point where the numbers will go) you can press the **PROG** key to "escape" what you were doing and return to normal operation mode.

TIP #3 → Whenever you have pressed a button (such as **SELECT LOCO**) and you want to keep what ever number that is already on the screen just press **ENTER**.

To operate the locomotive, the following controls are used:

The thumbwheel will increase/decrease speed. The speed control buttons on either side of the thumbwheel may also be used as desired to control the loco speed

Pressing the **DIRECTION** button will cause the loco direction to reverse.

CONGRATULATIONS! You are now operating one locomotive with DCC control.

Operating one locomotive is fun -- for awhile. But operating two or three locomotives is a lot more fun for a much longer time. Advancing beyond DCC testing requires decoder installation into additional locomotives and programming different addresses into each locomotive. Consult the **Programming Track** section of this manual to program your locomotives with a new address so you can run more than one at a time.

GENERAL SYSTEM INSTALLATION

DEVICE LOCATIONS

The physical locations for the Command Station and Power Station/ Reverse Block Controller can be anywhere. We *suggest* a location where the LED's on the front can be easily seen should there be a problem. Cab Bus panels such as the UTP and UTP-DIN are set up to use prewired four or six wire RJ-12 telephone cables to connect from panel to panel behind the layout fascia. Page **Error! Bookmark not defined.** has a diagram of the proper wiring for these cables. Those wishing to use the CBB01 CAB BUS BOARD will find that it comes with its own 7 foot six wire cable to connect to the next panel. This we feel is the average distance between plugs. In yard areas closer spacing may be needed. We suggest that a plug be no more than three feet from any siding where an operator would most likely stop and spend some time. Consider that operators will tend to gather at these panels so placement in crowded aisles may require care.

POWER REQUIREMENTS

The Command Station and Power Station can be powered by the same transformer as long as the transformer is sized large enough. Recommended transformer: 18v at 12 amps or more. Suppliers are Tony's Train Exchange model XFR/12 (1-800-978-7472 MC/Visa) or Allied Electronics part number: 836-6155 (1-800-433-5700 MC/Visa).

PROGRAMMING TRACK

The programming track is a separate section of track where programming (setting the locomotive address and/or other internal parameters). The programming track must be electrically separate from the main trackage. The end of a convenient spur track will work fine. Install insulated joiners or cut the necessary gaps in both rails, directly across the track from each other. Allow enough length for your longest locomotive.

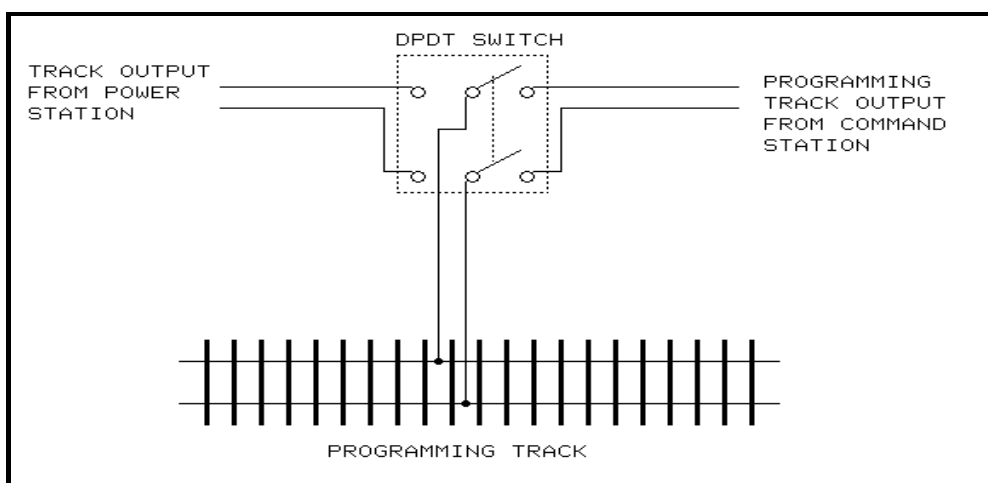

If desired, the programming track can be connected with a double-pole double-throw switch that is used to isolate this segment from the rest of your layout. This track is needed to complete the necessary start up programming for each decoder-equipped loco.

When using the Programming Track, the remainder of the layout is stopped. With NCE decoders, all parameters can be changed on the mainline, using the “Programming on the Main” feature, without shutting down the whole layout. Many other manufacturer’s decoders do not support Programming on the Main” so a programming track is required. The Programming track can be in multiple locations on the layout but, it is not used often and one convenient location will be plenty. Some owners have setup their shop loop to be DC, DCC, and DCC Programming Track, then they can do all the testing in their shop and have only ready-to-run loco’s on the layout.

REVERSE BLOCKS, WYES, AND CROSSOVERS

Reversing loops/sections still present the same potential for short circuits that conventional DC layouts have. You can use an additional PB-110 power booster to power the reversing section or a commercial auto-reverse loop module such as the Lenz LK100. See the PB-110 manual or the PB-100 section of this manual for installation notes on the LK100. The tail track of a wye (if it doesn’t connect to any other trackage) can simply be wired through DPDT contacts on the switch machine used to throw the switch that controls the tail track.

WIRING

If you already have a layout, your existing wiring most likely can be used without problems as long as it can handle a continuous 10 amp current. We suggest a “bus” of two large gauge wires (12-14 AWG)wires that follow the general track route of you layout with feeder wires to the track about every 3-6 feet. For the most trouble free operation we suggest a feeder to EVERY piece of rail. Don’t rely on

the rail joiners to handle 10 Amps of current. To prevent voltage drop over long runs a chart of recommended wire sizes is found below.

For the hobbyist wiring up a new layout our suggested wire sizes based on voltage drop are:

Runs to ten feet	#14
Runs to fifty feet	#12
Runs over fifty feet	#10

There is no special requirement for routing the power conductors with DCC. If you are going to have long runs of cab bus cabling along the front of the layout you may wish to run the track bus wires nearer the rear to prevent potential “crosstalk” between the track signal and the cab bus.

SYSTEM EQUIPMENT DESCRIPTIONS

The PH-10 (Powerhouse-Pro 10 Amp system) consists of two main boxes. The Command station is the brains of the system and the PB110A power booster supplies the power to the track. The Command Station is analogous to a stereo system tuner and the power booster is like the amplifier. You can add as many power boosters as you like if you need more power but only need one command station no matter how big the layout gets.

THE POWERHOUSE CS02 COMMAND STATION

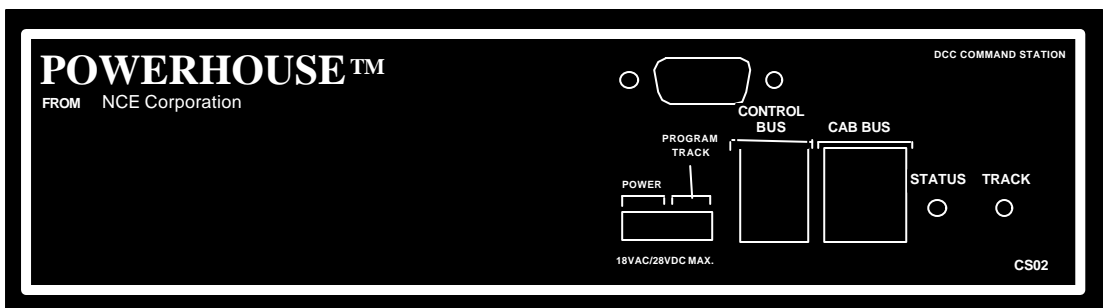

COMMAND STATION CONNECTIONS AND INDICATORS

POWER TERMINALS

These terminals have the same power requirements as the PB110a power terminals except it only needs 1.5 Amps. A 2 Amp 12.6 volt or higher transformer will work fine.

PROGRAMMING TRACK TERMINALS

The two connecting wires from your Programming Track should be connected here. We recommend using the last couple feet of a convenient spur track near

the front of the layout. Both rails must be gapped (insulated joiners) at the break between the programming section and the main trackage.

CAB BUS - TWO 6 WIRE RJ-12 SOCKET

You may plug a cab directly in to the jack or a Cab Bus cable may be connected to connect to additional connector panels around the layout. For small layouts and for checking-out the system before final wiring, the Cabs can be directly connected to the Command Station. For larger layouts this jack provides the ability to connect a longer/larger bus.

CONTROL BUS - 4 WIRE RJ-H SOCKET

Connect the 4 pin cable from this socket to the first Power Station.

COMPUTER INTERFACE PORT

This connector allows those hobbyists who wish to have access to their layout via a personal computer to do so. See the section on **RS232 SERIAL COMPUTER INTERFACE**.

TRACK LIGHT

Indicator light glows yellow to show operation is normal.

STATUS LIGHT- This light is always off.

REPLACING THE EPROM IN YOUR POWERHOUSE-PRO:

From time to time NCE distributes updates for the Powerhouse Pro system. These updates come in the form of an EPROM chip that replaces the existing EPROM in your command station.

1. Unplug the power plugs from the front of the Powerhouse (to make sure the power is off)
2. Remove the 4 cover screws from the Powerhouse and slide off the cover.
3. Pry the EPROM straight up from socket with a small flat blade screwdriver. Be sure to pry only under the chip and not the socket it is mounted in.
4. Carefully bend the leads of the new EPROM until they are parallel with each other.
5. Insert the new EPROM into the socket being careful to get pin 1 into the correct hole. Pin 1 is indicated on the chip by a "half moon" cutout in the end of the chip.
6. Examine the installation to ensure all 28 pins have engaged the socket correctly.

Replace the cover (angled edge goes toward the front of the Powerhouse) and its 4 retaining screws

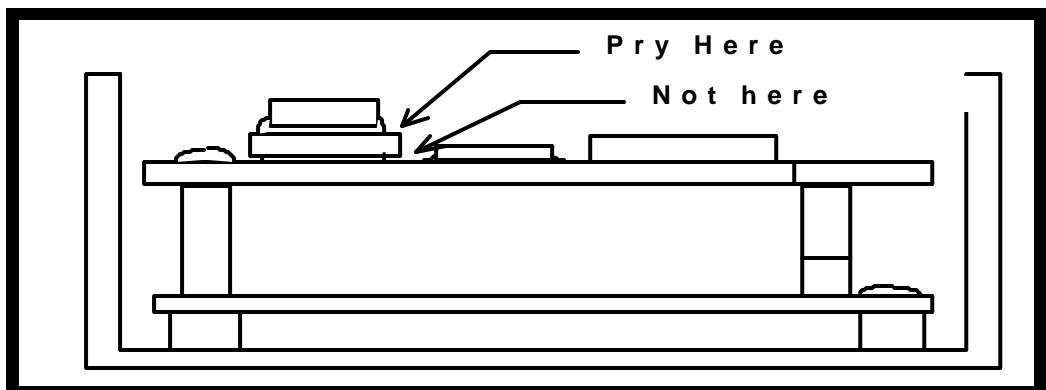
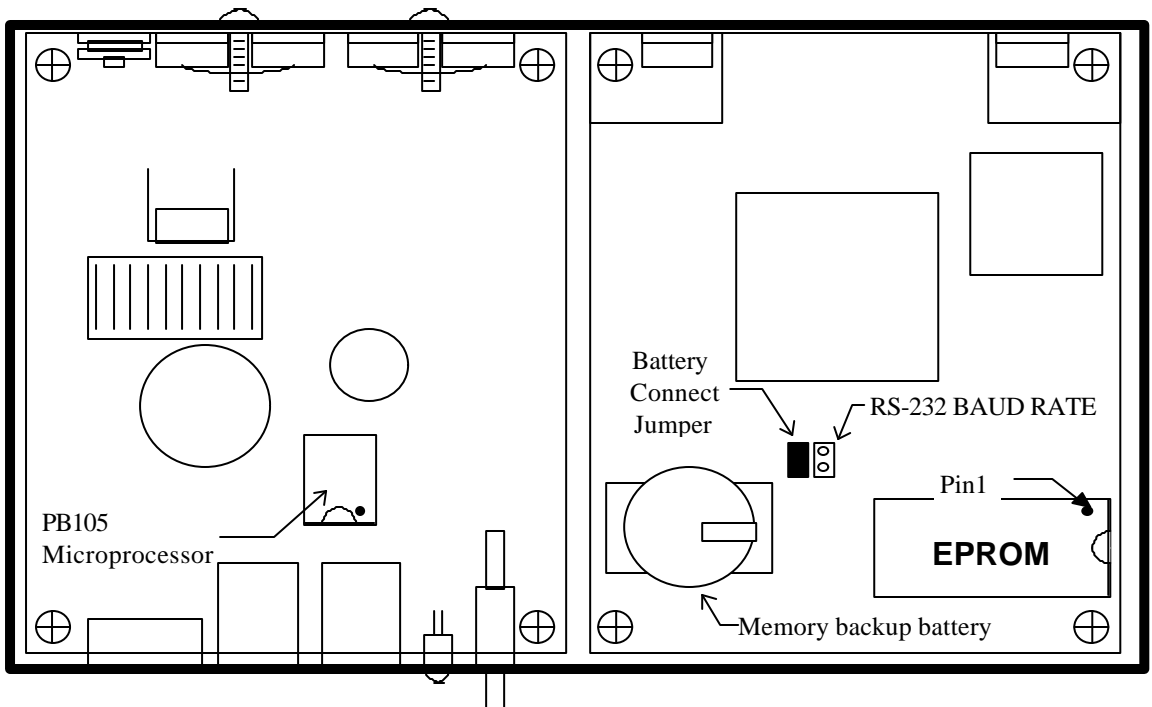

EPROM

The **EPROM** is replaceable for future software up-dates. Do not remove it for any other reason. As new software updates become available we will inform all registered owners by mail. At that time you will be provided with upgrade procedures and cost (if any).

BATTERY

A battery back-up is provided to allow the Powerhouse Pro to remember Cab assignments etc. when the power is turned off. The battery should be replaced with a **CR-2032 3 VOLT LITHIUM** in about 5 years. To replace the battery place your index finger under the upper PC board and your thumb on top of the small plastic "tongue" on the battery. Squeezing the tongue between the your thumb and finger will pop the battery up in the battery holder facilitating easy removal. The battery should be replaced with the power on if you wish to retain all system settings. Be careful to not **DROP** the battery on active circuitry if you replace it with the power on.

CONFIGURATION JUMPERS

BAUD RATE JUMPER

RS-232 data rate. The rate is 9600 baud with the jumper off and 19,200 with the jumper installed. Most commercial software only uses 9600 baud at this time. We recommend leaving the jumper **OFF**

BATTERY CONNECT JUMPER

With the jumper installed the battery is on. Should the operator want to reset the Command Station to "FACTORY SETTINGS" remove the jumper, cycle the power to the Command Station **OFF**, then **ON**. All changes have now been cleared. Now turn re-install the jumper. If you leave the jumper off the command station will not remember any of its settings after you turn the power off.

ANALOG LOCOMOTIVE CONTROL

We don't recommend the running of unmodified locomotives with DCC. Several customers have asked us how it can be done with the Powerhouse Pro so we've included instructions below on how to do this. Below is a diagram of the circuit to build an analog cab to plug in to the 9 pin computer port of the front of the PH-Pro. The Cab will have "center off" control of the locomotive, that is as the knob is turned to the left reverse speed will increase and as it is turned to the right forward speed will increase.

Warning: Several locomotive manufacturers consider the use of unmodified locomotives on DCC a condition that voids the warranty. Do not leave any unmodified locomotive on the DCC powered track rails for long periods of time if it is not running. Do not place a locomotive with a coreless motor on the rails at any time unless equipped with a decoder.

The required parts:

5K Ohm potentiometer (Radio Shack part number 271-1714)

1K Ohm 1/4 Watt resistor (Radio Shack part number 271-1321)

9 pin male "D" connector (Radio Shack part number 276-1537)

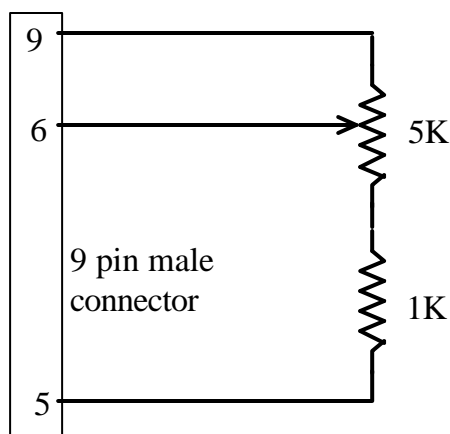

Analog Control Circuit

You will also have to add a jumper wire inside your PH-Pro system to enable use of analog control. The jumper is best placed on the bottom of the upper circuit board inside the PH-Pro. There are a total of 4 screws holding the circuit board in place, 2 on the front panel of the PH-Pro holding the "D" connector and two holding down the front of the PC board. See next page.

Installing the jumper:

- 1) Remove the 2 screws securing the “D” connector to the front panel
- 2) Remove the 2 screws holding the front of the upper PC board (some units have 1 screw)
- 3) Pull up at the rear of the board gently rocking it from side-to-side to disengage it from the connector attaching it to the lower circuit board.
- 4) Install the jumper as shown in Figure 2 from Hole A to Pin 6 of the “D” connector.
NOTE: there should also be a resistor already soldered in to Hole A
- 5) Re-plug the upper board to the lower board. Be careful to get all the pins lined up!
- 6) Replace the 4 screws
- 7) Test the analog control
- 8) Replace the cover

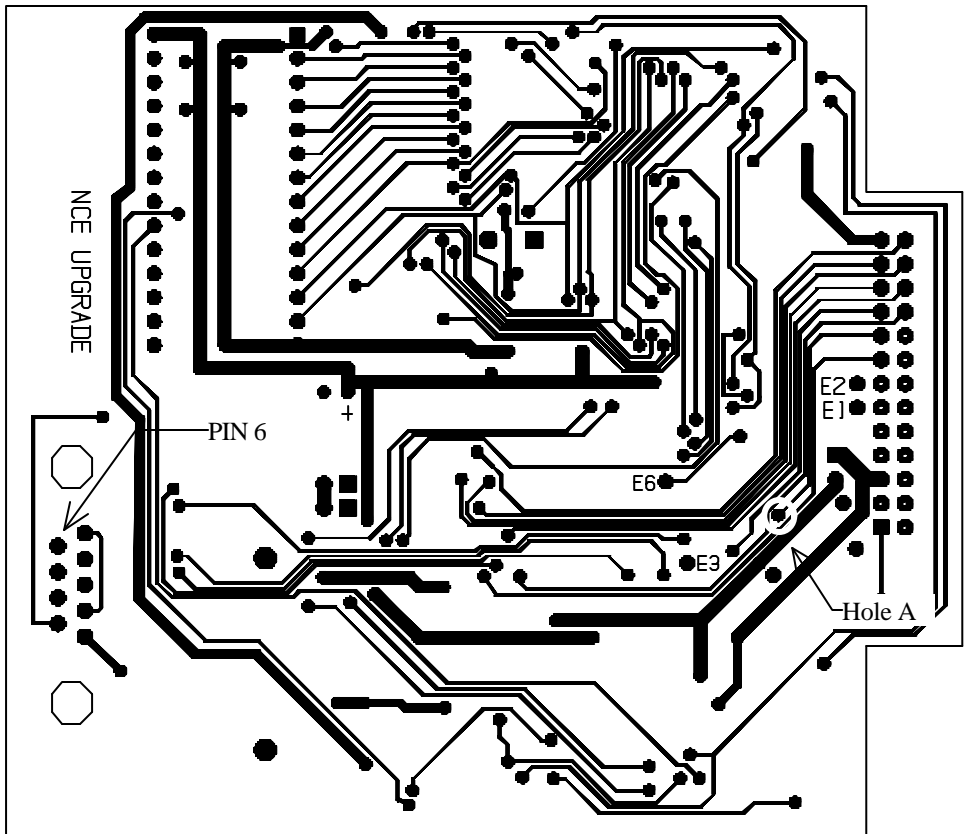

Bottom View Of PC Board

PB110A POWER BOOSTER

CONNECTIONS, CONTROLS and INDICATORS

Starting at the left side of the front panel, each terminal, socket, switch and indicator is explained below:

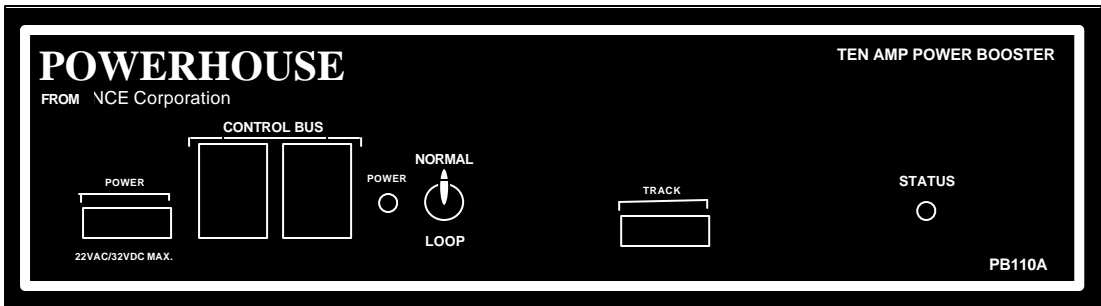

POWER connector

The Recommended input power for the PB-110A is 16-22 volts AC or 24-32 volts DC. The supply must be capable of supplying about 10 to 12 Amps (180-250VA) to get full output from the booster. We recommend the Hammond Manufacturing model 165T22. This is a 22 volt 12 Amp transformer. It is also sold as Allied Electronics part number 836-6185. (Allied phone number is 1-800-433-5700 MC/Visa accepted). Also usable is the Magnetek model F-259U, a 20 volt 10 Amp transformer (Allied part number 967-8442).

Do not use a power supply that can supply less than the recommended voltage and current. If a short circuit develops on the layout the PB110A will not be able to protect itself. The absolute maximum input voltage is 24 Volts AC or 36 volts DC. Do not exceed these ratings! Always measure the transformer voltage before connecting it to your PB-110A. A booster that has been 'over voltage'd' will almost certainly result in booster failure and void the warranty (we can tell if this has happened).

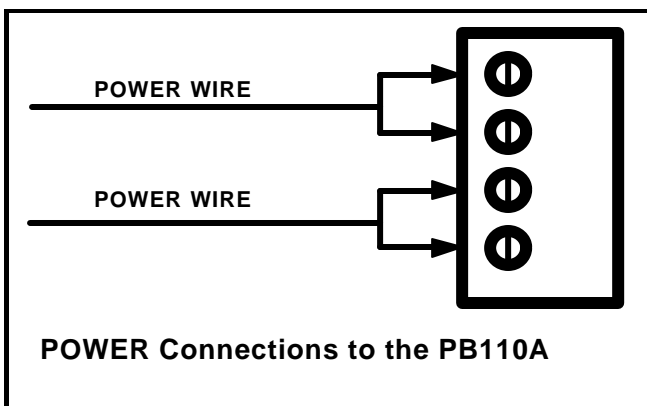

Input power from your power source goes into the PB-110A via the screw terminals of the green (or black) POWER connector. One power wire should go to **the left two terminals** and the other power wire should go to **the right two terminals**. This is to make sure the "per pin" power rating of the connector is not exceeded.

We recommend #14 AWG stranded wires for connection to power but the screw terminals of the black (or green) connectors are designed to accept wires only up to #16 AWG (1.3mm). Strip and prepare forked wire ends as shown below for insertion in to two terminals of the connector by dividing the strands of #12 or #14 wire into two groups. Do *not* tin the wires to prevent fraying.

If solid wire is used for track power, make a splice joint to stranded wire at some convenient place. Only stranded wire should enter the terminals for reliable contact.

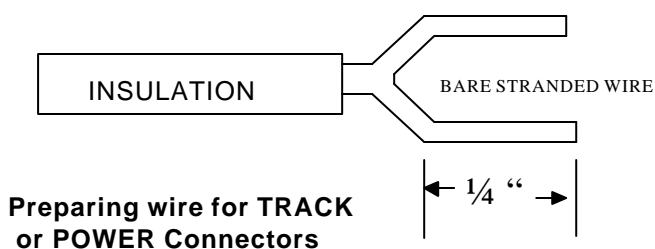

If you wish to purchase additional connectors you may use Digi-Key part number ED1962 or 277-1163. They are available from Digi-Key at 1-800-344-4539.

IMPORTANT NOTE: If you have more than one PB-110A, PB105, Powerhouse-Pro, or any Digitrax power booster in your system **we highly recommend grounding** all the power boosters together (except for any PB110A boosters used in “loop” mode) at a central earth ground point such as a cold water pipe. You can use one of the cover mounting screws as the ground point on your PB-110A. Failure to do this may result in voltages at power district boundaries that exceed the specifications of DCC decoders.

CONTROL BUS SOCKETS

The control bus sockets on the front of the PB-110A are paired to allow wiring the control signal coming from the command station to “daisy chain” through the booster.

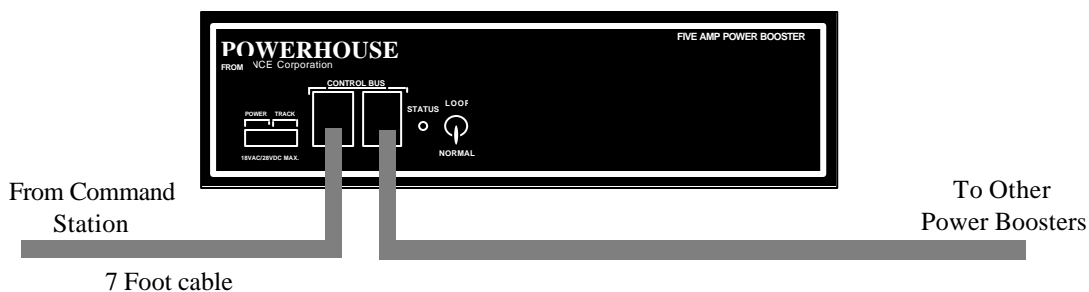

Use the supplied 7 foot cable to connect the PB-110A to your command station's CONTROL BUS socket. The remaining (unused) socket on the PB-110 can be used to connect to other boosters in daisy chain fashion. Use only the 4-wire RJ-H cable for this purpose. Longer cables may be used if more distance is needed between power stations. The last power station at the end of the daisy chain will have one empty socket. The PB-110A will place a nominal 10mA load on the command station control bus.

POWER LIGHT

The power light indicates when the PB110A is internally making regulated power suitable for normal operations .

LOOP/NORMAL SWITCH

In the "NORMAL" position, the power station is intended for use with normal trackage not reverse loops. If a short circuit is detected, the power station will simply shut down for about 2-3 seconds and will then automatically reset. In the "LOOP" position, the power station should be wired to a reverse loop power district. The power station will then sense an impending short circuit as metal wheels arrive at or depart from the reverse loop. The power station will then automatically reverse track polarity and the train proceeds without hesitation. To use the PB-110A as a reverse loop controller it is necessary that the power booster connected to the mainline be of 10 Amps or more. Otherwise the mainline booster will just shutdown when the locomotive crosses the gaps into the 10 Amp powered reverse loop. **YOU NEED TWO BOOSTERS TO MAKE USE OF THE AUTOMATIC REVERSE LOOP FEATURE.** Any PB110A used in "loop" mode must be supplied from a separate transformer. Do not connect the chassis ground of any PB110A used in "loop" mode, the booster must remain "floating" for the auto-reverse feature to work correctly.

TRACK TERMINALS:

Wires from these terminals go to the track. If more than one booster is connected to the layout, be sure the left track terminal on all boosters is consistently wired to the same rail. This will ensure you have the same "phase" as you cross power district boundaries. In a reverse loop power district, it doesn't matter which terminal is wired to what rail since the booster will automatically reverse polarity when required. The LOOP/NORMAL discussion above describes this in more detail. Always use wire of sufficient gauge (#14 minimum) to connect to the layout. Power "drops" of #18 or #20 wire to a larger wire bus under the track are fine as long as the length of each drop to the main bus is less than 12".

Use of a smaller bus will prevent the booster from detecting a short circuit and may be a fire hazard.

Track wiring connects to the PB-110A via the screw terminals of the green (or black) TRACK connector in the same manner as the power wires. One track wire should go to

both the left two terminals and the other track wire should go to **both the right two terminals**. This is to make sure the “per pin” power rating of the connector is not exceeded.

The voltage to the track is dependent on the setting of the internal voltage adjustment, as discussed above. The DCC track voltage is factory adjusted to the 16.0 (+/- 0.1) volts for O and G Scales. The voltage is adjustable from 11.5 to 22 volts by means of a blue adjustment potentiometer inside the PB110A. See page 8 for directions on setting the track voltage.

STATUS LIGHT

This light will illuminate light steadily under normal operations. Flashing indicates an abnormal or fault condition. Here is a description of the various conditions indicated by the status light.

- ⇒ **Steady on** - Track power is on and operations are normal.
- ⇒ **Rapid flash** - No DCC signal from command station (control bus cable is unplugged, programming track in use, etc.)
- ⇒ **Slower steady flash** - Short Circuit (over current shutdown). The booster will shut down for 2-3 seconds or until short or load of over 10.6 Amps is removed.

CONNECTING THE PB-110A TO OTHER SYSTEMS

WIRING TO A LENZ COMMAND STATION

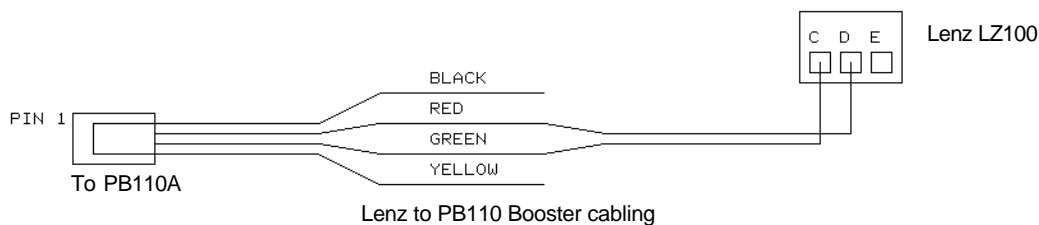

This wiring diagram is provided for the operators that have switched from an Existing LENZ system to NCE boosters. Lenz does not provide a ground point.

WIRING TO A DIGITRAX SYSTEM

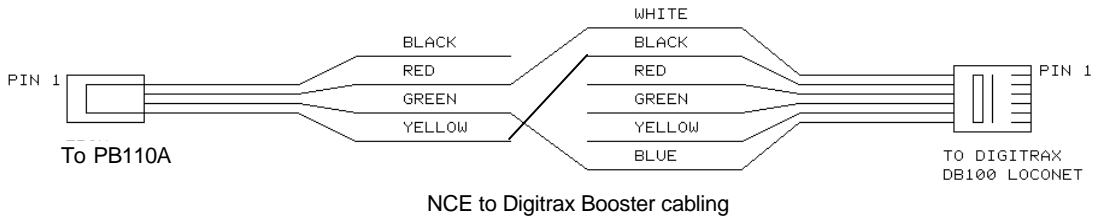

This wiring diagram is provided for the operators that wish to add an NCE power booster to their existing DIGITRAX system. This cable splicing is required to the first DB100/150/200 only. Always leave the "Ground to Sync" Jumper installed.

Don't forget to ground the PB-110 chassis to the ground terminal of the DB100/150/200.

TRACK VOLTAGE ADJUSTMENT

The track voltage is adjustable from 11.5 to 22 volts. Adjustment requires opening the case of the booster and turning the blue adjustment potentiometer(s) as shown below.

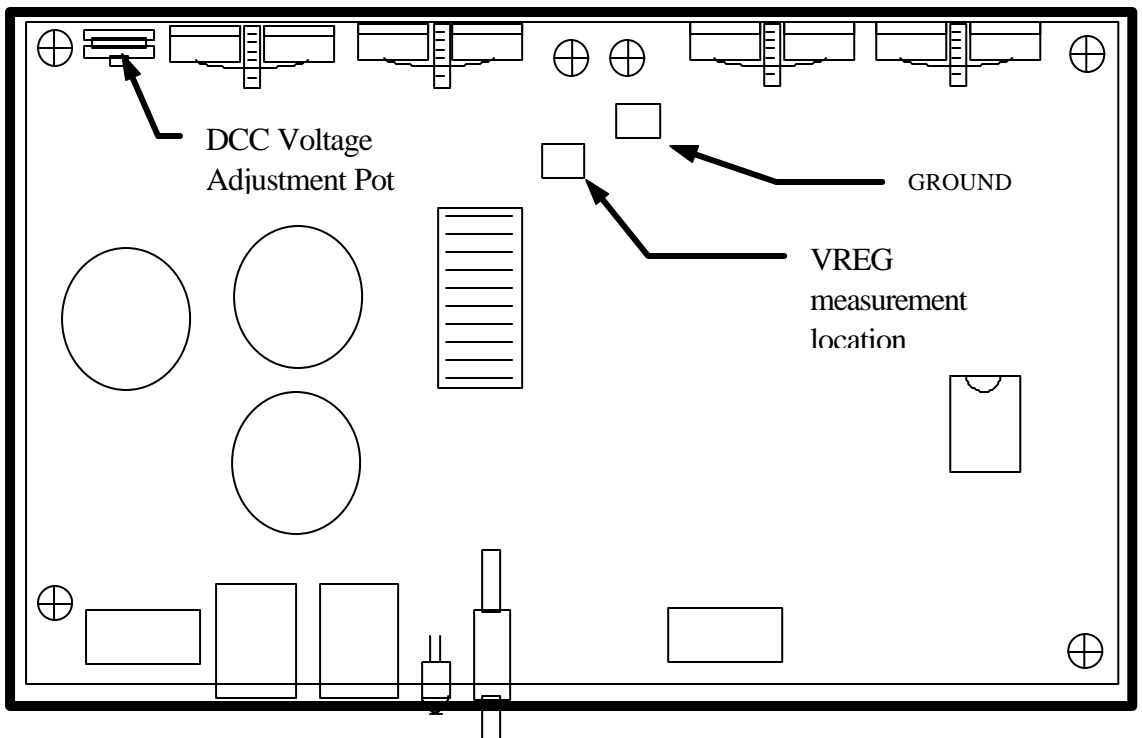

Adjusting the DCC output voltage:

- 1) Set voltmeter to DC volts

- 2) Touch minus (black) lead of meter to the GROUND pad on the PC Board
- 3) Touch plus (red) lead of meter to the rectangular silver circuit board pad marked VREG
- 4) Turn DCC voltage adjustment pot to desired output voltage
- 5) Adjust all boosters to the same voltage. Otherwise you will see a speed variation when you cross power district boundaries

NOTE 1: Adjust the voltage with no appreciable load on track. The output voltage will rise slightly as more current is drawn to compensate for the drop in the output MOSFETs and associated wiring.

NOTE 2: If you have a means of measuring the track voltage (a typical "True RMS" reading meter with a 100V range) the voltage can be adjusted through a hole in the back of the PB-110A chassis without opening the cover.

NOTE 3: We do not recommend setting the track voltage above 16 volts for O-Scale. It is very hard on any lights you may have installed in locomotives. Most O-Scale locomotives are designed to run on 14.25 Volts DCC (about 12 volts to the motor) for prototype speed.

at Walmart, auto parts stores, and most gas stations. This fuse does not eliminate the need for proper fuses in the input power source. The fuse is located near the lower left corner of the printed circuit board as shown in the earlier diagram illustrating how to adjust track voltage.

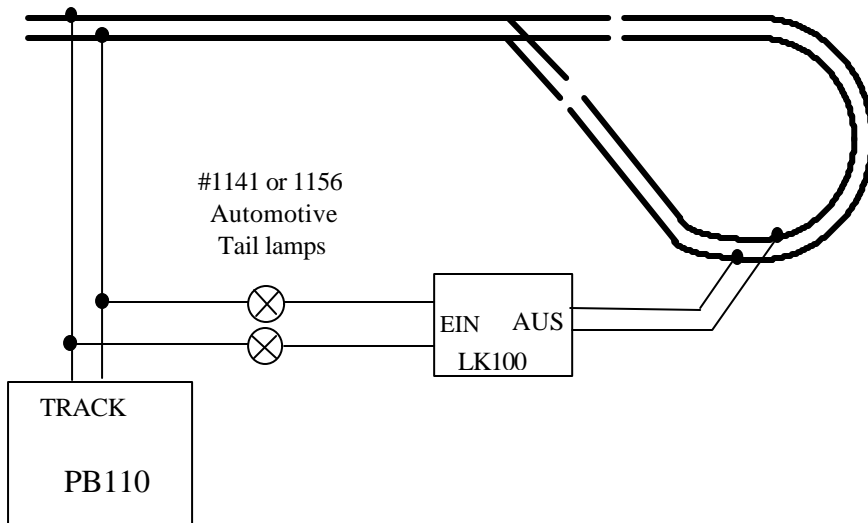

Using your PB110 with a Lenz LK100 Auto-reversing module

THE PRO CAB

Just as every locomotive has a separate number (address in DCC terms) each cab needs a separate address so the command station can distinguish one cab from another. Each ProCab is shipped from the factory with the address of 2. If this is not your first ProCab you will have to change the address before using the cab. To easily change the address:

Power up your Powerhouse system.

1. Plug in the ProCab cable to the CAB BUS connector of the Powerhouse
2. Unplug your procab at the base of the cab
3. Press and hold the SELECT LOCO button while re-plugging in the cable you just removed from the cab
4. You should see the following display on the cab:
NCE PROCAB V1.3
CAB ADDRESS = 02
5. The cursor will be flashing over the 0 of "02". Type in the new cab number. In this case, you will press "3" (valid range = 2-63) followed by ENTER.
6. Press PROG/ESC to skip setting all the other cab setup options. They will be discussed later in this manual.

THE LCD SCREEN

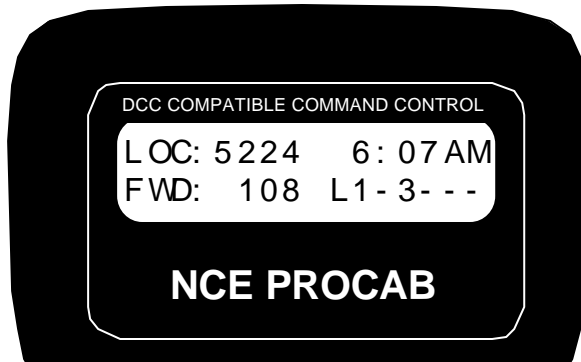

The LCD screen provides you with messages from the Powerhouse Pro Command Station. This information includes: locomotive status, scale time, command prompts and messages regarding programming decoders. The drawing above shows how the display looks during normal operation. The top line of the display includes the locomotive number being controlled and the scale time. The second line shows the direction, speed and status of the locomotive function outputs. Decoder functions are represented with "L" for headlight or the function number 1 through 6 being ON. A dash ("-") indicating the function is OFF

LOCOMOTIVE CONTROL AREA

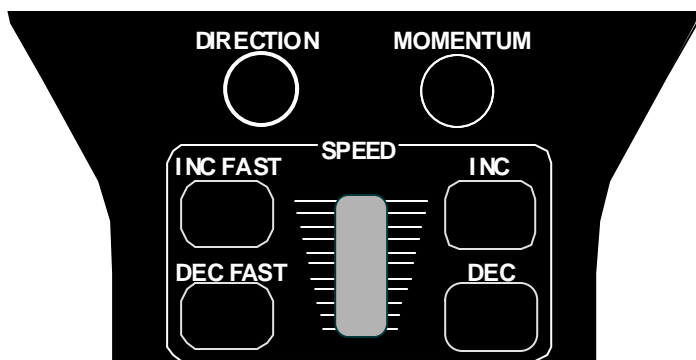

DIRECTION

The **DIR** key changes the direction of your loco or consist. The current direction is displayed as the first three characters of the second line on the screen. This button is disabled if the cab is in Yard mode.

MOMENTUM

This key changes the acceleration/deceleration rate of the currently controlled locomotive/consist. Note: This feature will be activated with the next (free) upgrade of our Powerhouse Pro.

SPEED CONTROL SECTION

The digital encoder equipped ProCab allows you to use both the speed buttons and the knob for controlling the speed of your locomotive. The left two keys increase or decrease the speed by either 4 or 10 speed steps, depending on the speed step mode (14, 28 or 128), whereas the right keys increase and decrease the speed by one speed step at a time.

The knob increases the speed by pushing it up and decreases the speed when it is pulled down.

Digital encoder equipped ProCabs have a feature called ballistic tracking. The faster you turn the knob the faster it will increase or decrease the speed. This rate is adjustable from 0-7. The factory default value is 3. See the Cab Setup section later in this manual.

Note: if you have a potentiometer speed control in your cab, the buttons will not work unless you turn them on and the potentiometer off. This can be quickly changed by holding down the Select Loco key when re-plugging in the Cab Cable, this will put the Cab in its internal set up mode.

Note: Speed buttons are disabled if the ProCab is in Yard mode.

COMMONLY USED BUTTONS

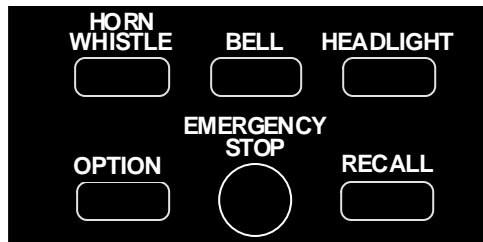

HORN/WHISTLE

Factory default is to operate function 2 when this button is pushed. This can be changed in the **Set Cab Params** menu of the command station. Unlike other keys which toggle the functions on/off this key blows the horn as long as the key is held down. Pressing the **2** key will still toggle the function on or off.

BELL

Factory default is toggle function “3” on or off with each button press. This can be changed in the **Set Cab Params** menu.

HEADLIGHT

Toggles the Headlight on and off. It is defined as Function 0, and pressing the 0 (zero) key will perform the same function, but we felt the headlight warranted its own button and a more convenient location.

OPTION

This button comes factory set up to act as the BRAKE key. Pushing this button will set the speed of the currently controlled locomotive or consist to zero. This button can be programmed to act as any button you wish (see the CAB SETUP section later in this book).

EMERGENCY STOP

Pressing **EMERGENCY STOP** once will stop the active loco/consist for this Cab only. Speed will be immediately set to zero (no momentum). Loco is restarted by changing the speed step or direction.

WHOLE LAYOUT EMERGENCY STOP

Pressing **EMERGENCY STOP** three times in succession will bring the *entire* layout to a stop by shutting off track power. “LAYOUT STOPPED!” will be displayed and is cleared by pressing the **ENTER** key. Only the Cab that executed the Emergency Stop can clear it. Each Loco or Consist can now be

restarted by sending it a command, such as a speed step increase or decrease, or by toggling a Function output.

RECALL

This button toggles between the last two to six trains addressed. **RECALL** allows you to keep two to six locomotives and/or consists active in the command station memory and access them in “round-robin” fashion with each press of the button. Think of **RECALL** as being a set of memory slots. To put a locomotive in a recall “slot”, press **SELECT LOCO** and enter the loco or consist to be operated. To put another locomotive in the next slot press **RECALL** to access the next slot. Now press **SELECT LOCO** and enter the second loco. When additional trains are to be added either a “slot” with “000” or an expendable loco/consist must be displayed on the screen. Whatever is on the display will be replaced with the new loco/consist.

The number of **RECALLS** for each cab can be changed within the “**SET CAB PARAMS**” menu (see **PROG** button description). The factory set value is two. You may also “clear out” any locomotives in the recall slots using the “**SET CAB PARAMS**” menu. We don’t advise using **RECALL** in Yard mode.

LOCO and ACCESSORY SELECTION GROUP

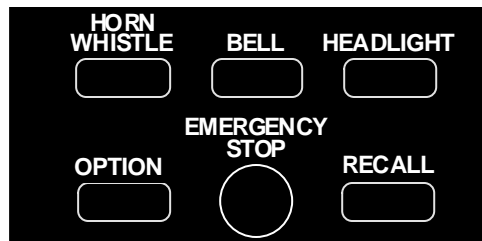

SELECT LOCO

This allows the selection of a locomotive/consist to operate. Press this key, then the loco/consist number, then **ENTER**.

MACRO

When this key is pressed you are prompted to enter the macro number, then press **ENTER**. Macros are used to control one or more accessories with a single command.

This is especially useful for selecting a route through a switch ladder in a staging yard or complex trackwork where it would be inefficient to throw several switches by selecting the individually. Macros are explained in detail in our system reference manual.

SELECT ACCESSORY

For controlling “accessory” decoders that operate accessories such as switch machines, lights, signals, etc.

DATA ENTRY/FUNCTION CONTROL

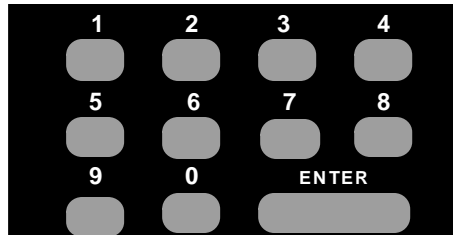

NUMBER KEYS

The keys **0** through **9** serve two purposes. First, when operating a loco/consist if a number key is pressed it toggles the corresponding function on the loco (if that function is connected and supported by the decoder). The second purpose is for typing in numbers such as when selecting locomotives or responding to screen selections during programming.

ENTER

Used to confirm numerical inputs and select a programming mode.

CONSIST SETUP GROUP

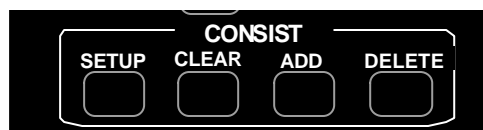

Supports not only the advanced decoders that address the Extended Packet Format but also the entry level decoders that are presently on the market. For complete operating instructions on consist makeup's read the section on **SETTING UP A CONSIST** in the Powerhouse Pro Reference Manual.

SETUP

Starts the procedure for either creating an advanced or old style (some call it Universal) consist.

CLEAR

Disbands (breaks up) a consist.

ADD LOCO

Adds a locomotive to a consist.

DELETE LOCO

Drops a locomotive from a consist.

PROGRAMMING and EXTENDED FUNCTION CONTROL

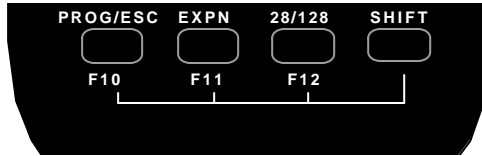

PROG/ESC

Provides selection of the various system menus available for setting up decoders, Cabs, time, etc.

This button also doubles as an “**escape**” key during number/data entry. Whenever the cursor (flashing rectangular box) is shown on the cab display to indicate the cab is waiting for data to be input you can press **PROG/ESC** to cancel the data entry and return to normal operations.

The following menus are accessed round robin fashion with each successive press of the **PROG/ESC** key when in normal operations:

- ⇒ First press: Program on the Main (Operations Mode programming)
- ⇒ Second Press: Assign loco to Cab
- ⇒ Third Press: Set Fast Clock
- ⇒ Fourth Press: Use Programming Track
- ⇒ Fifth Press: Set up Command Station
- ⇒ Sixth Press: Set up Cab Paramters
- ⇒ Seventh Press: Program accessory decoders on the mainline
- ⇒ Eighth Press: Set up Macros (switch route control)
- ⇒ Ninth press: return to normal operations

Pressing ENTER at any of the above menus will select that menu, pressing PROG will step to the next menu.

EXPANSION

Reserved for future features. At present it toggles between the display of lines 1 and 2 of the LCD display and lines 3 and 4. These lines have nothing to display this time. The LoComand (K² Engineering), RR&CO (Juergen Freiwald) and ENGINE COMMANDER (KAM Industries) PC software programs are able to send messages to the engineer via these two lines.

28/128

Provides the ability to toggle between 14, 28, and 128 speed step operation of the active loco/consist. The 14 speed step is for first generation decoders. The 28 speed step is second generation decoders and the momentum operation of advanced decoders. 128 speed step is now supported by all decoders except MRC and provides the smoothest operation. When using this key the lower right will display the speed step mode you have selected. This display will be set to the normal operation display the next time a function is toggled or **ENTER** is pressed.

SHIFT

This button gives each key on the Pro Cab an “alter ego”. When pressed and held while pressing another key on the cab the alternate value of that key can be used. For example: To access the (future) the extended function F10 you simply press **SHIFT** and **PROG** at the same time to activate **FUNCTION 10**. Every key can programmed to any current or future feature we may think up. This is like having a whole cab full of **OPTION** keys. Each key is preprogrammed at the factory to one of these alternate uses. Try pressing **SHIFT** and **4**. This takes you directly to the **USE THE PROGRAMMING TRACK** menu. A list of the shifted keys is tabulated on the next page.

When the radio control option is installed the **SHIFT** button, when pressed, will also turn on the backlight of the LCD for about 5 seconds. If more keys are pressed within the 5 second period the time on will be extended by 3 seconds each time a key is pressed. This will save **LOTS** of battery power by not having the backlight on continuously.

CAB SETUP

The ProCab has various internal setup parameters and operating modes. The following steps describe the various parameters you may change to customize the cab to your liking.

To access the cab set up mode:

- 1) Turn on the command station
- 2) Unplug your cab from the command station

- 3) Press and hold down the SELECT LOCO button on the cab while plugging in the cab. The cab will now enter its internal setup program. At any time you may press PROG/ESC to leave set up mode.
- 4) Press ENTER to accept the current cab address (unless you want to change it). To change the cab address type in a new address such as 3 followed by the ENTER key. If you make a mistake just unplug the cab and re-plug it while holding down the SELECT LOCO key.
NOTE: If you program the address to zero the cab will reprogram itself to the original factory values, including the cab address, which will be set to 2 .
- 5) At the “1=YARD 2=NORMAL” prompt you can press ENTER to accept the current operating mode. To select between “normal” operation where the speed knob stops at speed 0 when turned all the way down or “yard” mode. In yard mode as the knob is turned down to zero it will reverse locomotive direction and start increasing speed in reverse as the knob turning in the “down” direction is continued. Pushing the knob up will reduce the reverse speed to zero the increase it in a forward direction. **The factory setting is 2 for “normal” Operation**
- 6) Press ENTER to accept the existing Ballistic Tracking Rate or enter a new rate. Entering a low number will cause speed knob to change locomotive speed more slowly as the knob is turned, larger numbers will cause a greater change of speed as the knob is turned. **The factory setting is 3 and values from 0-7 will be accepted**
- 7) Press ENTER to accept the Speed Button Repeat Rate. This is the rate at which the 4 speed control buttons repeat. Smaller values will make the buttons repeat faster. The acceptable range is 16 to 255. **The factory setting is 32.**
- 8) Press ENTER to accept the current Speaker On Time or enter a new value. Smaller values generate a short “beep” as the speed knob is turned through zero when in yard mode and larger numbers generate a longer beep. Values from 0-99 are accepted. **The factory value is 3.** NOTE: the beep will only work if there is a speaker installed.
- 9) Press ENTER to accept the current OPTION key value. If you wish to change it enter a number from the Key Table Chart following this section. **The factory value is 94** so the OPTION button will act as BRAKE button.
- 10) Press ENTER to accept the “shifted” value for key number 1. If you wish to change it enter a number from the Key Table Chart following this section. See the Table of Factory Default Values for Shifted Keys on page 10 for the preset factory values.
- 11) Use the same procedure described in step 10 to accept or program keys number 2 through 32. Remember you can press PROG/ESC to exit at any time. If you stick it out to key 32, press ENTER to return to normal operations mode.

Key Table Chart

Value	Key Name	Value	Key Name
64	Enter	96	Assign Loco to Cab
65	Program	97	Program on Main
66	Recall	98	Set Clock
67	Direction	99	Use program track
68	Setup consist	100	Setup command station
69	Add loco to consist	101	Setup Procab
70	Delete loco from consist	102	Setup macros
71	Kill consist	103	Setup old consist
72	Select loco	104	Setup advanced consist
73	Horn/Whistle	105	Display LCD lines 3 and 4
74	1 Speed step faster	106	Forward
75	1 Speed step slower	107	Reverse
76	Emergency Stop	108	“Key 32” from old CAB01
77	Bell	109	“Key 33” from small cabs
78	Select Accessory	110	reserved
79	Expn (Expansion) key	111	Momentum (future)
80	Headlight, Zero key	112	F10
81	F1, number 1 key	113	F11
82	F2, number 2 key	114	F12
83	F3, number 3 key	115	reserved
84	F4, number 4 key	116	reserved
85	F5, number 5 key	117	reserved
86	F6, number 6 key	118	reserved
87	F7, number 7 key	119	reserved
88	F8, number 8 key	120	reserved
89	F9, number 9 key	121	reserved
90	4/10 speed steps faster	122	reserved
91	4/10 speed steps slower	123	reserved
92	Macro	124	reserved
93	14/28/128 select	125	“no key” pressed
94	Brake (factory setting)	126	reserved
95	Do not use	127	do not use

CAB BUTTON NUMBERING SCHEME



**TABLE OF FACTORY DEFAULT VALUES
FOR “SHIFTED” KEYS**

Key #	Value	Description	Key #	Value	Description
1	67	Direction	17	96	Assign Loco -> Cab
2	94	Brake	18	98	Set Clock
3	90	Increment 4/10 steps	19	99	Use Program Track
4	74	Increment 1 Step	20	100	Setup Command Station
5	91	Decrement 4/10 steps	21	101	Setup Cab Parameters
6	75	Decrement 1 Step	22	118	reserved
7	123	reserved	23	102	Setup Macros
8	81	Headlight	24	108	reserved
9	122	reserved	25	119	reserved
10	125	reserved	26	103	Setup Old Consist
11	116	reserved	27	108	reserved
12	109	reserved	28	120	reserved
13	121	reserved	29	115	reserved
14	117	reserved	30	112	Function 10
15	111	Momentum (future)	31	113	Function 11
16	97	Program on Main	32	114	Function 12

PROCAB SPECIFICATIONS:

Size: 8-3/4 x 3-5/8" x 1"

Power Requirements: 8 VDC 40mA (backlight off)

8 VDC 120mA (backlight on)

Maximum speaker/buzzer current: 15mA @ 5 volts DC.

Replacement Encoder: Bournes or Digikey part #3315C-1-006

Replacement Potentiometer: Bournes or Digikey part #3310C-1-203

Note: To switch from encoder to pot operation a 1.8K-2.2K resistor must be soldered at the surface mount resistor site labeled CONFIG (see previous page) on the ProCab PC board. Be sure to solder the pot at the correct location (R13... not the encoder location) on the PC board. You will also have to carve or machine a flat on the shaft of the pot or encoder for the knob before installation.

Note: Only cab versions 1.2 and higher can be switched from pot to encoder or vice versa.

6 WIRE CAB BUS CABLE WITH RJ-12 CONNECTORS

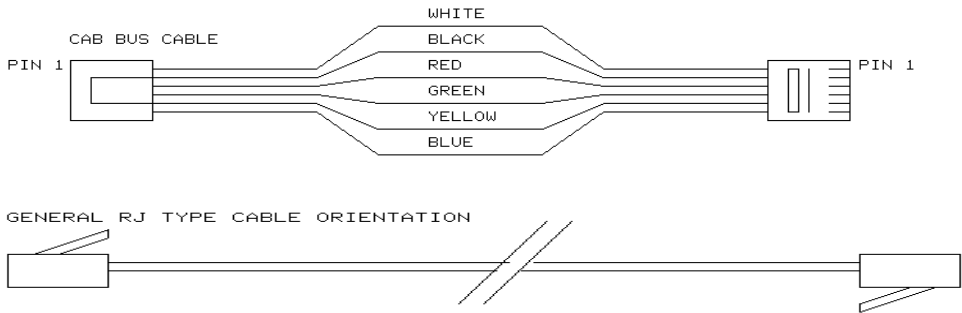

Pin #	Color	Description
Pin 1	White	No Connection, reserved
Pin 2	Black	Ground
Pin 3	Red	- RS-485
Pin 4	Green	+ RS-485
Pin 5	Yellow	+12 volts
Pin 6	Blue	No Connection, reserved

RJ-12 TO 3 WIRE PHONE PLUG CABLE

Compatible with our CBB01 cab bus adapter boards and Wangrow CCP01 connector panels

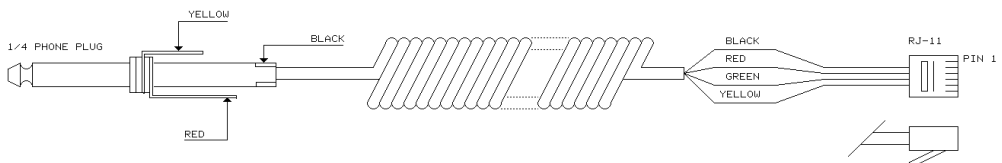

DECODERS

PRECAUTIONARY INSTALLATION NOTES.

1. MAKE SURE NO METAL PART OF THE LOCOMOTIVE TOUCHES ANY METAL PART OF THE DECODER. APPLY ELECTRICAL TAPE TO THE INTERIOR OF THE LOCO AT ANY QUESTIONABLE POINTS.
2. THERE MUST BE NO ELECTRICAL CONNECTION BETWEEN THE MOTOR AND THE RAILS. BOTH MOTOR TERMINALS MUST BE ELECTRICALLY ISOLATED FROM THE MOTOR FRAME AND BODY.
3. IF YOU USE METAL COUPLERS MAKE SURE THE COUPLERS ARE INSULATED FROM THE FRAME. THIS CAN CAUSE MYSTERIOUS PROBLEMS WHEN RUNNING TWO OR MORE LOCOMOTIVES COUPLED TOGETHER.
4. DO NOT USE CONVENTIONAL DECODERS WITH CORELESS MOTORS.

DECODER INSTALLATION

- Test the locomotive to assure good analog operation. Poor running locomotives will not run well with DCC either. Test the loco under a “stalled” condition. First connect ammeter between the DC power supply and the track. Removing the loco’s shell. Now stall the motor by squeezing the flywheel until it stops. Note the reading on the meter with the loco operating at full voltage. The decoder rating needs to exceed the highest amperage reading otherwise the decoder will cause the loco to have intermittent stops when operating at the decoders rated amperage.
- We suggest installing the wiring harnesses with plugs for all leads being used in order to facilitate decoder removal in the future.
- Lights and other function loco’s should not exceed the values listed for each decoder. Nor should their total exceed the amount of current remaining after testing the loco motor “stalled”. The Function common (blue wire), is track voltage. To cut the voltage in half, use one of the rails as the common.
- Make a wiring diagram of your locomotive’s motor power and lighting. Copy it and add how you are going to insulate the motor from the frame, if it is not

already insulated, and where you are going to cut the wires from the track pickups to the motor and lights. LGB locomotives can be tricky here.

- The power for the Functions normally is connected to the Blue wire. This will supply the lights with 14-15 volts (for the NORMAL setting). If you connect the lighting common to one of the rails (Red or Black), the voltage to the lights will be half (7 - 8 volts).

Place the loco on the programming track and refer to the section “PROGRAMMING ON THE PROGRAMMING TRACK”. All decoders come from the factory with the address “3”.

DO-408 - 4 AMPERE DECODER

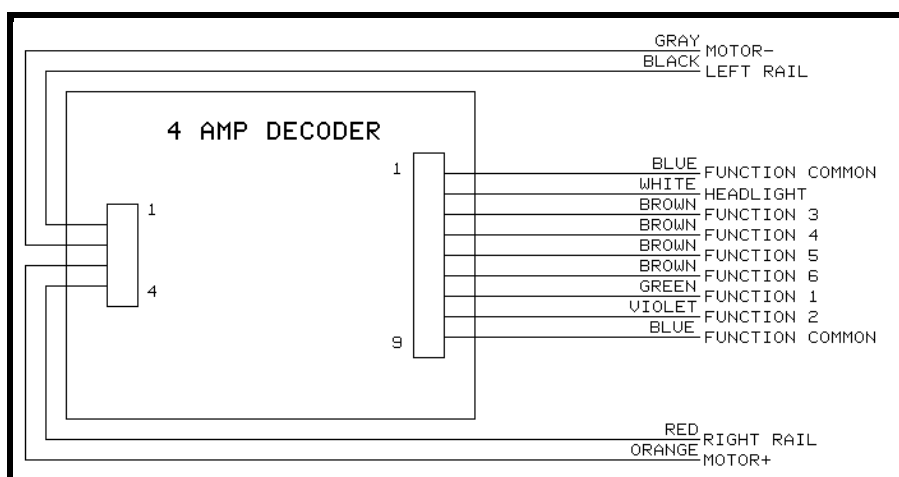

SPECIFICATIONS:

- 4 ampere motor capacity (8 amp stall, 12 Amp peak) for permanent magnet type DC motors. The motor current rating is typical based upon available cooling air. A Weaver loco draws about 1.5-2.5 amperes on average but has a stall current of about 8-10 Amps. LGB locomotives are significantly less current
- 7 function outputs on a plug-able wiring harness plus one solder contact for function 7. Function Current ratings:
 F0 (HEADLIGHT) 200ma
 F2 through F7 - 100ma each
- Thermal overload protection.
- Programmable starting voltage.
- Operates with 128 speed step (feels like analog DC control) or 28 speed step with momentum.

When wiring, the right hand rail is the rail to the right of the observer standing between the rails with their back to the front of the locomotive, also referred to as

the “engineers side”. For traction systems, the overhead wire is considered the right hand rail.

LOCO WIRING DIAGRAM

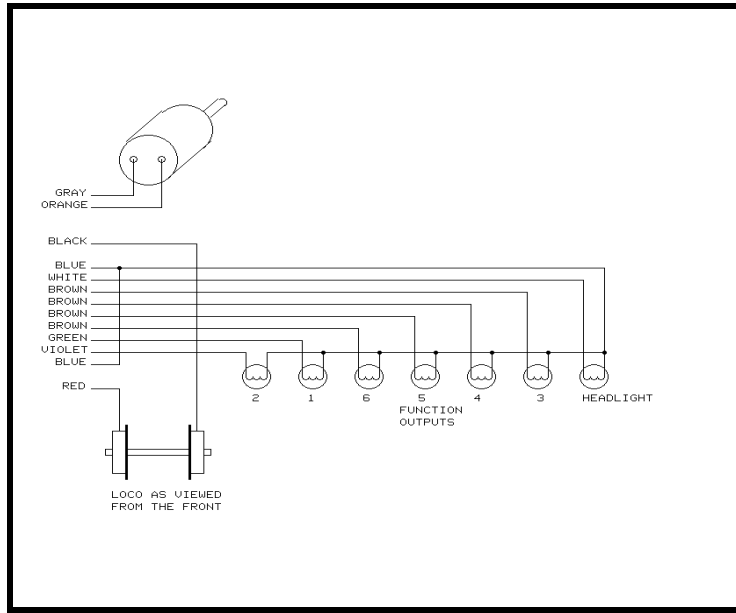

The Decoder is protected by a thermal overload detector. It has a peak current output of approximately 8-12 Amps. If more than 4 Amps are drawn continuously, the Decoder will likely overheat and shut down. It will restart after several seconds of cooling. The motor is stopped, and all function outputs are turned off during the over-temperature shutdown.

OPERATING PROCEDURES

THE “NORMAL” DISPLAY

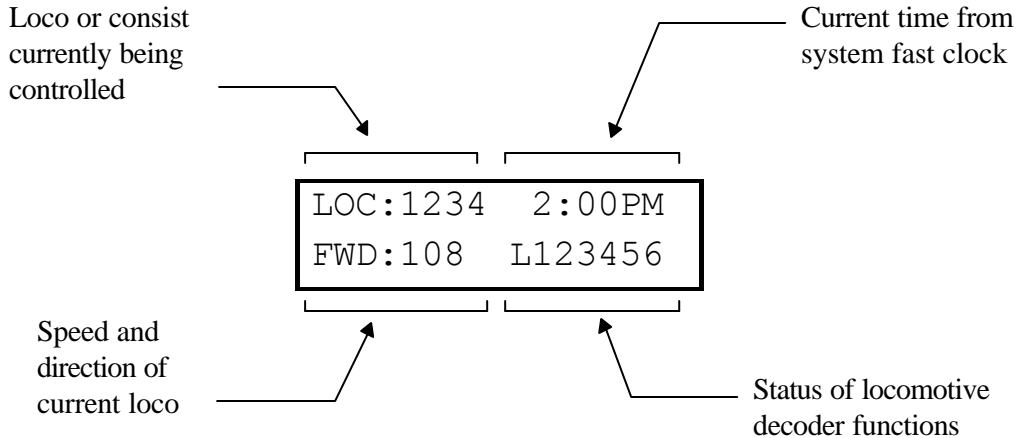

TOP ROW OF DISPLAY

LOC: indicates that a locomotive is being operated.

CON: indicates that a consist is being operated.

2:00PM: Scale Time in either 12 hour or 24 hour format.

BOTTOM ROW OF DISPLAY

FWD: or REV: Indicates the current direction of loco or consist

108 - Indicates the speed step that the active loco/consist is presently set at.

L123456 or - - - - -

Indicates which function outputs are ON. Those outputs that are OFF are displayed as dashes (-).

Other status information may temporarily be displayed in this area.

SELECTING A LOCOMOTIVE OR CONSIST

First a word about locomotive addresses. A decoder can have 2 different addresses, the Short Address (values from 1-127) and the Long Address (sometimes called 4 digit with a range of 0000-9999). A decoder can use one or the other but not both at the same time. Some entry level decoders such as MRC can only use the Short Address.

As you can see above there is an overlap in the address ranges between the short and long address. You can have a long address of 6 and a short address of 6. They are *not* the same. To use a short address (range 1-127) it is selected on the cab by entering only the significant digits (no zeros before you get to the numbers). To enter a long address in the range of 1-127 put a zero before the digits. A long address between 1 and 127 will have an asterisk (*) before the loco address on the cab display as below:

We find that most modellers rarely use long addresses in the 1-127 range.

<p>LOC:*006 2:00PM ENTER LOCO: _</p>

To select the locomotive:

- Press the **SELECT LOCO** button
- Enter the 1 to 4 digit address of the loco/consist to be operated. A “Leading Zero” is necessary for **long** addresses below 128. An asterisk will be displayed before any long address below 128 (example above).
- Press the **ENTER** key.

Locomotive address examples:

4421 = Long Address

006 = Long Address as Entered.

*006 = Long Address as Displayed

45 = Short Address

LOC: will be displayed when addressing a single locomotive

CON: will be displayed when addressing a Consist.

CONTROLLING HEADLIGHTS AND OTHER DECODER FUNCTIONS

Pressing **HEADLIGHT** will alternately toggle the headlight of the locomotive on and off.

To toggle other functions simply press the number key that corresponds to the function you wish to control. E.g. - The '1' key controls function 1.

Your cab will display which functions are on and off in the lower right corner of the display. The letter 'L' stands for Headlight (Function 0) and numbers 1-6 stand for functions 1-6 (functions 7 and 8 are not displayed on the cab but work if you push the buttons). In the example below the headlight, functions 2 and 6 are on.

LOC : 4449	xx : xxPM
FWD : 025	L-2---6

CONSISTS - OLD AND ADVANCED CONSISTS EXPLAINED

Before setting up any consist an explanation is needed to understand the operating differences between the old style consist (also called brute force or Universal) and advanced consist operations. Basic decoders that have a long or short address but no CONSIST address (MRC and Digitrax 120 series Decoders) can not be used with advanced consistings.

ADVANCED

Decoders that support advanced consistings have an additional short address, the CONSIST address, besides their normal Long and Short addresses. The consist address is stored in CV19 and can have a value of 1-127.

A decoder considers itself in a consist if the Consist Address (CV19) is something other than 0 or 128. A decoder is added to a consist when the Powerhouse command station sends an advanced decoder a command to set the consist address in the decoder to the consist number. The decoder will now use this new consist address for speed and direction commands. This has many advantages including less need for communications on the track and no need for the operator or command station to keep track of which locomotives are in which consist on the layout.

Each locomotive in an advanced consist will still respond to function or programming commands at the original locomotive address. This means the operator can turn lights or other functions on or off for each locomotive individually.

To kill an entire consist, a command is broadcast on the tracks for each decoder with that consist number to clear its consist address and return to individual operation. Locomotives can also be individually dropped from a consist. You can also add locomotives to a consist after the initial setting up of that consist.

Advanced style consists can easily be taken from layout to layout and they will continue to operate as a single unit.

OLD STYLE (also called brute force or Universal consistings)

With an Old Style (also called brute force or Universal consistings) the command station keeps track of each locomotive in each consist in the memory of the command station. Each command from the Cab generates a separate command to each of the decoders in the consist. These extra speed commands on the track have significant ramifications if you have a lot of consists operating at one time as in a club situation. The effect is to slow down locomotive response to the cab signals.

Use this method of building a consist with MRC and Digitrax 120 series decoders. Decoders in an old style consist have no knowledge of being in a consist and will not operate as a unit when moved to another layout.

SETTING UP AN ADVANCED CONSIST

To set up a consist press **SETUP**. This screen allows you to choose the type of consist to be created. For those consists that only contain advanced decoders, press **ENTER** to select the advanced mode. An advanced consist has *no* limit as to the number of loco's assigned.

NOTE: you can not setup, add a loco to, or delete a loco from a consist while the locomotive is moving. It must be at speed 0. Decoders will not accept consist commands while they are in motion. This prevents reception of false consist make/break commands due to electrical noise generated by the wheels rolling on the track.

```
CONSIST 2:00PM
ENTER=ADV 1=OLD
```

ENTERING THE CONSIST NUMBER

The consist number can be any number from 1 through 127. Enter the number followed by pressing the **ENTER** key. If you have locomotives on the layout using short addresses make sure you don't pick an address already in use. This is one reason to use long addresses with your loco fleet. It will keep the short addresses free for consists.

```
SETUP 2:00PM
CON ADDR: _
```

ENTERING THE LEAD LOCO NUMBER

Entering the lead loco number is optional but recommended. The command station keeps track of consists by their lead loco number. The locomotive is the loco that the command station will send function commands to. For example: headlight on/off commands. If the command station did not know the lead loco it would not know which locomotive should have the headlight turned on or off.

The lead loco number also act as an *alias* for the consist number entered above. Say you have a bunch of consists stored on staging tracks and you wish to operate

one of them. After the consist is set up, you can select the consist by pressing **SEL LOCO** then entering either the lead loco number or the consist number. The lead loco number is typically easiest to remember because it is the number printed right on the locomotive. The consist number may not relate to any visible or easily remembered number.

```
SETUP  2:00PM
LEAD LOCO:  _
```

Enter the lead loco number followed by pressing the **ENTER** key.

ENTERING THE LEAD LOCO DIRECTION

If the locomotive is to operate in the forward direction press **ENTER**. Press the **DIRECTION** key if you wish to have the locomotive operate in the reverse direction. Subsequent presses of the **DIRECTION** key will keep changing the direction. When you get the direction you desire press the **ENTER** key.

```
CONSIST  2:00PM
DIR THIS LOCO: F
```

This informs the decoder if the loco is in the line-up facing forward or reverse. For instance, in an A-B-A consist the lead A unit and the B unit will be setup in the Forward direction, and the second A unit will be setup in the Reverse direction.

ADDING ANOTHER LOCO TO THE CONSIST

At this point you can start to add more locomotives to the consist. Enter the next locomotive (decoder address) followed by pressing the **ENTER** key. If you don't want to add any more locomotives to the consist just press **ENTER**.

```
CONSIST  2:00PM
ADD LOCO:  _
```

ENTERING THE LOCO'S DIRECTION

```
CONSIST  2:00PM
DIR THIS LOCO: F
```

As with the lead locomotive, this informs the decoder if the loco is in the line-up facing forward or reverse.

If the locomotive is to operate in the forward direction press **ENTER**. Press the **DIRECTION** key if you wish to have the locomotive operate in the reverse direction. Subsequent presses of the **DIRECTION** key will keep changing the direction. When you get the direction you desire press the **ENTER** key.

At this point you will be prompted to add additional locomotives. If you don't want to add any more locomotives to the consist just press **ENTER** with out entering an address.

ADDING A LOCO TO AN ADVANCED CONSIST

SELECT THE CONSIST

```
ADD LOCO 2:00PM
CONSIST ADDR:_
```

Press **ADD LOCO**. Enter the number of the existing consist, or lead loco (alias), to which the loco is to be added and then press the **ENTER** key.

ENTERING THE LOCO NUMBER

```
ADD LOCO 2:00PM
ADD LOCO: _
```

Enter the loco's number and press the **ENTER** key.

ENTERING THE LOCO'S DIRECTION

```
CONSIST 2:00PM
DIR THIS LOCO: F
```

If the loco is to operate in the correct direction press **ENTER**, otherwise press the **DIRECTION** key followed by pressing the **ENTER** key. This informs the decoder if the loco is in the line-up facing forward or reverse.

DROPPING A LOCOMOTIVE FROM AN ADVANCED CONSIST

SELECT LOCO

```
DEL LOCO 2:00PM
```

```
ENTER LOCO: _
```

This will drop the loco identified from whatever consist it was part of. There is no need to know the consist number for this operation.

CLEARING AN ADVANCED CONSIST

SELECT THE CONSIST TO BE CLEARED

```
LOC:4449 2:00PM  
KILL CONSIST: _
```

Enter the consist or lead loco number and press **ENTER**. This sends a command to all decoders with this consist address to clear the consist address from the decoder. All loco's that were assigned to this consist will no longer respond to the consist address.

CHANGING THE LEAD LOCO

Under some circumstances it is desirable to change which locomotive is to act as the lead loco of a consist. One of these circumstances is when you want to drop the lead loco from the consist. The command station will not allow you to drop the lead loco so you will want to assign a new locomotive as lead. Then you will be able to drop the old lead loco.

```
SETUP 2:00PM  
CON ADDR: _
```

The first step is to press **SETUP**. Then enter either the consist number of the current lead loco number (address). Then press **ENTER**.

```
SETUP 2:00PM  
LEAD LOCO: _
```

Enter the *new* lead loco number and press **ENTER**.

If the new lead loco is to operate in the forward direction press **ENTER**. Press the **DIRECTION** key if you wish to have the locomotive operate in the reverse direction. When you get the direction you desire press the **ENTER** key.

```
CONSIST 2:00PM  
DIR THIS LOCO: F
```

You are now finished changing the lead locomotive of the consist.

OLD STYLE CONSISTS

SETUP AN OLD STYLE CONSIST

```
CONSIST  2:00PM
ENTER=ADV 1=OLD
```

To set up a consist press **SETUP**. This screen allows you to choose the type of consist to be created. For those consists that will contain any of the basic decoders, press **1**. Please note that the limit on an old style consist is four loco's.

INITIAL SCREEN DISPLAYED

```
CON: 000 2:00PM
000 000 000
```

This screen is displayed to show all 4 "slots" for loco's in the consist are empty. Press the **ENTER** key to continue.

Press the **ADD LOCO** key.

ENTERING THE LOCO NUMBER

```
CON: 000 2:00PM
ADD LOCO:  _
```

Enter the loco number followed by the **ENTER** key. The first loco to be added will be the lead loco (the lead loco number will be displayed on the screen during normal operation). The consist will respond to this number.

ENTERING THE LOCO'S DIRECTION

```
SETUP  2:00PM
DIR THIS LOCO: F
```

The locomotive direction is assumed to be forward, if it is to operate in reverse press the **DIRECTION** key. This informs the command station if the loco is in the line-up facing forward or reverse. This effects only the direction of the loco, not lighting. Press the **ENTER** key to continue.

The operator needs to press **ADD LOCO** for every loco to be added. This operation leaves the consist as the active unit for this Cab. By pressing **RECALL** the operator can change to another loco/consist but the old style consist will stay with this Cab until it is either passed by assigning it to another Cab or is cleared.

OLD STYLE CONSIST FULL

CON: 012 2:00PM CAN NOT ADD LOCO

The consist contains four loco's which is the maximum amount that we support in this style of consist. Press the **ENTER** to continue.

FOLLOW-UP SCREEN

CON: 012 02:00PM CONSIST NOW FULL

This screen reaffirms the previous screen. Press the **ENTER** key to continue.

SCREEN DISPLAYED WHEN OPERATING OLD STYLE CONSISTS

CON: 042 2:00PM 008R 101 4449R

The **R** indicates that the loco is reversed in the consist.

Loco 42 is a basic (short address) decoder and the Lead Loco.

Loco 8 is a basic decoder operating backwards.

Loco 101 is a basic decoder.

Loco 4449 is an advanced decoder operating backwards.

ADDING A LOCO TO AN OLD STYLE CONSIST

CON: 012 2:00PM FWD: 000 L- - - - -
--

You can only add a loco to an active consist on your cab. If the consist is not active press **RECALL** until you have the consist active or acquire the consist from another cab by “ASSIGN LOCO TO CAB”.

ENTERING THE LOCO NUMBER

```
CON: 012 2:00PM
ADD LOCO: _
```

Enter the loco number to add and press **ENTER**.

ENTERING THE LOCO DIRECTION

```
CON: 012 2:00PM
DIR THIS LOCO: F
```

If the locomotive is to operate in the forward direction press **ENTER**. Press the **DIRECTION** key if you wish to have the locomotive operate in the reverse direction. Subsequent presses of the **DIRECTION** key will keep changing the direction. When you get the direction you desire press the **ENTER** key.

DROPPING A LOCO FROM AN OLD STYLE CONSIST

```
CON: 012 2:00PM
FWD: 120 L- - - - -
```

You can only delete a loco from an active consist on your cab. If the consist is not active press **RECALL** until you have the consist active or acquire the consist from another cab by “ASSIGN LOCO TO CAB”.

SELECT THE LOCO TO DELETE

```
DEL LOCO 2:00PM
ENTER LOCO: _
```

This will drop the intended locomotive from old style consist. Enter the loco number and the press **ENTER**.

ERROR MESSAGE

```
DEL LOCO 2:00PM
NOT IN CONSIST:
```

This message will display when the loco selected is not in the active consist.

CLEARING AN OLD STYLE CONSIST

```
CON:12  2:00PM
024 056 078
```

You can only clear an old style consist if it is the active consist on your cab. If the consist is not active press **RECALL** until you have the consist active or acquire the consist from another cab by "ASSIGN LOCO TO CAB".

CONFIRM THE CONSIST THAT IS TO BE KILLED

```
KILL?  02:00PM
ENTER=NO 1=YES:
```

Press 1 to clear the consist from the Command Station memory. All locomotives that were in the consist must now be selected and operated independently.

CONTROLLING TURNOUTS AND OTHER ACCESSORIES

ENTER THE ACCESSORY NUMBER TO BE OPERATED

```
CONTROL 02:00PM
ACC NUMBER: _
```

Press **SELECT ACCY** key. Enter the address of the accessory to be operated. Followed by pressing the **ENTER** key.

TURN ACCESSORY ON OR OFF

```
ACC: 003 02:00PM
1=N(ON) 2=R(OFF)
```

Press **1** to turn accessory ON. (Switch machine set to Normal)

Press **2** to turn accessory OFF. (Switch machine set to Reverse)

USE MACROS TO CONTROL TURNOUTS

MACROS EXPLAINED

Macros are really a list of switches or accessories you wish to operate as a group. There are a total of 200 of them, with each one capable of controlling up to 10 accessories (or switches).

ENTER THE MACRO NUMBER TO BE EXECUTED

```
LOC: 1023 2:00PM  
MACRO NUMBER:_
```

- Press **MACRO** key.
- Enter the number of the macro (0-199) to be executed
- Pressing **ENTER**.

MACRO EXECUTE

```
LOC:1023 2:00PM  
MACRO NUMBER:_
```

To execute a macro press the **MACRO** key and then enter the macro number (0 to 199)

MACRO NOT DEFINED

```
ERROR: 02:00PM  
-MACRO IS EMPTY-
```

This message will be displayed if no macro has been programmed for the number entered.

MACRO PROGRAMMING

To program a macro see the PROGRAMMING MACRO section.

HELPFUL HINTS FOR OPERATION

- Passing an old style consist: Use **ASSIGN LOCO TO CAB** to transfer an old style consist to any other Cab on the system. This causes a *swap* between the active loco/consist on your Cab and the active loco/consist on the target Cab.
- Nesting consists: A large freight is approaching a long grade and helpers are needed. The train's consist is made up of advanced decoders as is a pusher consist. The pusher consist is brought out of the siding at the base of the grade and put in place. A "old style" consist is now set up containing the freight's consist number and the pusher's consist number and operated to the grade crest. Upon reaching the cutoff siding at the crest of the grade the "old style" consist is killed and the pushers are addressed to move to the siding. The freight consist continues on.
- If you are using the Pro Cab thumbwheel in 128 speed step mode, the numbers go up by 2 if you are moving the Dial slowly. This is to reduce the "bounce" between two adjacent numbers. To get to the other number, press the INC or DEC. Use this technique when you want to alter the speed by a small amount.
- Use 3 Recalls to operate a Consist.
 - Recall 1 is used for the Consist address. This control's the speed and direction.
 - Recall 2 is used for the Lead Loco. This controls the lights
 - Recall 3 is used for the Sound Unit address so you do not toggle the functions in other decoders when operating the horn or bell.
- When setting up an old style Consist, you may want to use a Loco number that does not exist for the first Loco (Consist address). This will allow you to recall the actual lead Loco to operate the headlight, and the sound Loco to operate the Horn and Bell.
- If the Loco is lurching, the track or wheels might be dirty. Confirm this by pressing the **28/128** key until the display reads **SPD 128**. In NCE based decoders this completely turns off momentum. If the Loco now runs OK, check the track and wheels for dirt. If the Loco still runs erratically, the pickup within the Loco should be checked.
- If Cab does not respond after plugging it in, press the **ENTER** key. This will cause it to exit from any mode it was in when it was un-plugged.
- If you really want to find your dirty track and loose connections, set a loco in the 28 speed step mode with the acceleration set to about 50 and slowly travel around your layout. Every time a dirty spot or loose connection

causes the decoder to loose power, it resets itself, causing the loco to stop and then slowly accelerate again.

- When making your own cables using RJ plugs be SURE the connectors are “flipped” over at opposite ends of the wire.

Connecting the Wires

- The terminal blocks for the Command Station and Power Booster require the wire to be stripped back about 1/2 to 5/8 inch. This is longer than you would expect by just looking at the front of the unit. Be sure to insert the wires all the way into the terminal block before tightening the screw.
- Sometimes the wires "catch" as you are trying to take them out of the terminals and seem to defy removal short of violently ripping them out. If this happens tighten the screw back down and unscrew it again while pushing the wire slightly back into the terminal. Nine times out of 10 this helps.

Power booster

- Your power booster can put out considerable power. Sufficient input power is required for it to perform to its optimum. We suggest an 18 volt 10 to 12 Amp transformer. Proper AC wiring and fusing to this transformer is required to prevent melted wiring or possibly a fire.
- If you have A 10 Amp power booster it is internally protected by an internal 15 Amp automotive type fuse.
- The 10 Amp power booster is factory set to put out 15.5-16 volts to the track in the "normal" position and 18 volts in the "adjust" position. The adjust position (18 volts) is the correct voltage recommended by the NMRA for G Scale. The voltage delivered to the motor or a loco will typically be about 2 volts less than the voltage on the track.

Using the Pro Cab

- In DCC there are 2 kinds of addresses (loco numbers), long and short. When entering the address of the loco you wish to control long addresses from 1 to 127 are entered by preceding the actual number by a zero. Short addresses are entered without a leading zero. Long addresses in the range of 1 -127 are displayed on your cab with an asterisk before the loco number. ie: "*042" indicates the long address for loco forty-two and "042" indicates the short address. Most modern decoders made since 1997 support long (4 digit) addresses. Older Lenz, Digitrax and all MRC decoders only support the short address.

- When entering numbers if you make a mistake there is no "erase" or "backup" key. If you keep typing digits the display will clear allowing you to start entering your number over again.
- If you wish to abandon what you are doing when in the middle of entering a number push the "PROG" key and you will be returned to normal operation.
- During various operations where you are doing something other than normal loco operation such as "set up consist" or "select accessory" speed control of the loco is not available, however the Emergency Stop will still work if you need to stop your loco.
- During programming on the programming track the command station first reads the value of a location (such as "short address" or "acceleration") and displays it on your cab. If you wish to accept this value just press enter to continue or type in a new number if you want to change it.

Programming Track

- The command station checks for a short circuit on the programming track before applying power. If your loco has lights or other current drawing devices wired directly to the track instead of a decoder function output the command station will probably think it has a short and will say "SHORT DETECTED" each time you start to program this loco. If you wish you will be allowed to override the short and continue. This short detection is there to protect decoders from damage if they are miswired. For this reason we find always try a new decoder installation on the programming track first instead of putting it directly on the layout. If the programming works the installation is most likely correct.
- MRC decoders can be easily programmed using "REG" programming (option 3 at the "PROG TRK" menu).

CV to equivalent Register mapping for MRC decoders:

CV #	Description	Register #
1	Short Address	1
2	Start Voltage	2
3	Acceleration	3
4	Deceleration	4
29	Configuration byte	5

PROGRAMMING PROCEDURES

PROGRAM MODE SCREENS EXPLAINED

To access the various programming modes, press the **PROG** key. The following messages will be displayed for each press of the **PROG** key. When the desired mode is displayed, press the **ENTER** key to enter that mode. To quickly get to a programming mode, press the **PROG** key and then press the number of the screen. If you have pressed the **PROG** key by mistake, or want to exit out without having to press the **PROG** key several times, press the **0** key.

To program locomotive decoders on the main (OPS mode) press **ENTER**.
Screen 1.

```
SEL MODE 02:00PM
PROGRAM ON MAIN
```

To assign a locomotive/consist to a Cab press **ENTER**.
Screen 2.

```
SEL MODE 02:00PM
ASSIGN LOCO->CAB
```

To start, stop, or set the System Clock press **ENTER**.
Screen 3.

```
SEL MODE 02:00PM
SET SYSTEM CLOCK
```

To program on the program track press **ENTER**.
Screen 4.

```
SEL MODE 02:00PM
USE PROGRAM TRK
```

To set command station parameters press **ENTER**.
Screen 5.

```
SEL MODE 02:00PM
SET CMD STATION:
```

To set the Cab parameters press **ENTER**.
Screen 6.

```
SEL MODE 02:00PM
SET CAB PARAMS
```

To program accessory decoders on the main press **ENTER**.
Screen 7.

```
SEL MODE 02:00PM
PROG ACCESSORIES
```

To setup macros (routing through turnouts) press **ENTER**.
Screen 8.

```
SEL MODE 02:00PM
PROGAM MACROS
```

Refer to the following sections for the

individual programming instructions. To escape from any programming session press the PROG key.

PROGRAMMING MENUS

The following is a chart of all of the programming modes and each section within each mode. Refer to the detail in the following sections.

PROGRAMMING ON THE MAIN	59
WHICH LOCO.....	59
WHAT TO PROGRAM.....	59
CONSIST PROGRAMMING	59
ACCELERATION	60
DECELERATION.....	60
CONFIGURATION VARIABLE (CV) PROGRAMMING.....	60
ENTER CONFIG VAR NUMBER	60
ENTER CONFIG VAR VALUE.....	60
SET CONFIGURATION VARIABLES	60
SPEED STEPS - 28 OR 14.....	61
DC MODE.....	61
SPEED TABLE SELECTION.....	61
ADDRESS TO BE USED	62
ASSIGNING A LOCO TO A CAB	63
ASSIGN THE LOCO	63
ASSIGN THE CAB	63
SET THE SYSTEM CLOCK.....	63
STOPPING THE CLOCK.....	64
SETTING 12 or 24 HOUR MODE	64
ENTERING THE HOUR	64
ENTERING THE MINUTE	64
ENTERING THE RATIO.....	64
STARTING THE CLOCK.....	64
PROGRAMMING TRACK.....	65
WHAT TO PROGRAM.....	65
STANDARD PROGRAMMING.....	65
DECODER MANUFACTURER.....	66
DECODER VERSION.....	66
ENTERING THE SHORT ADDRESS	66
ENTERING THE LONG ADDRESS.....	66
ACCELERATION	67
DECELERATION.....	67
START VOLTAGE.....	67
CONFIGURATION VARIABLE (CV) PROGRAMMING.....	67
ENTER CONFIG VAR NUMBER	69
ENTER CONFIG VAR VALUE.....	69
SETTING THE CONFIGURATION VARIABLES	67

SPEED STEPS - 28 OR 14.....	68
DC MODE.....	68
SPEED TABLE SELECTION.....	68
ADDRESS TO BE USED	68
REGISTER PROGRAMMING.....	69
ENTER THE REGISTER TO PROGRAM.....	69
ENTER REGISTER VALUE.....	70
SETUP COMMAND STATION.....	71
DISPLAY SOFTWARE VERSION AND DATE.....	71
NUMBER OF RECALLS	71
NUMBER OF STOP PACKETS	71
NUMBER OF TEMP PACKETS	72
NUMBER OF ACCESSORY PACKETS	72
NUMBER OF PROGRAM PACKETS	72
NUMBER OF HORN LOOP	72
TEST FOR LOCO IN USE.....	72
HIGHEST CAB NUMBER.....	73
LAST CAB TO PROGRAM ON MAIN	73
LAST CAB TO ASSIGN LOCO.....	73
LAST CAB TO SET CLOCK.....	73
LAST CAB TO USE PROGRAM TRACK	73
LAST CAB TO SET COMMAD STATION	74
LAST CAB TO SET ITSELF	74
FUNCTION REPEAT RATE.....	75
SET CAB PARAMETERS	75
SETTING THE CAB ADDRESS	75
CAB ADDRESS	76
SETTING THE SPEED CONTROL VIA KNOB OR KEYS	76
ASSIGNING THE HORN/WHISTLE FUNCTION	76
ASSIGNING THE BELL FUNCTION.....	77
PROGRAM ACCESSORIES ON THE MAIN.....	78
ENTER THE ACCESSORY ADDRESS.....	78
ENTER THE CV NUMBER	78
ENTER THE CV VALUE.....	78
PROGRAM MACROS.....	78
SELECT MACRO PROGRAM OR REVIEW	79
ENTER THE MACRO NUMBER	79
ENTER THE ACCESSORY ADDRESS.....	79
SELECT THE ACCESSORY OUTPUT	79
ENTER THE REVIEW MACRO NUMBER.....	80
REVIEW MACRO.....	80
END OF MACRO REVIEW	80

PROGRAMMING ON THE MAIN

Programming on the Main is also called Operations (OPS) Mode Programming. OPS Programming allows you to change parameters while the loco in on the main track (even while it's *running*). This does not affect other locomotives on the track. You can even change the locomotive address.

WHICH LOCO

OPS PROG 02:00PM PROG LOCO: _

Enter the address of the locomotive you wish to program. If you want to program the locomotive you are currently operating just press **ENTER**.

WHAT TO PROGRAM

LOC:1022 02:00PM 1=CON 2=CV 3=CFG

This screen allows the user to select the specific area that is to be programmed. Press **1** to program the acceleration and deceleration adjust parameters of all locomotives in a consist, press **2** to program any CV, and press **3** to set the CV 29 (CFG register).

CONSIST PROGRAMMING (option 1)

The Acceleration and Deceleration Adjusts *add* to the Acceleration and Deceleration programmed in Program Track programming (see page 65). It is possible to lower the normal value by using “negative” numbers. The Cab will not let you enter negative numbers directly, so you will have to enter a high positive value that represents a negative number. The following chart shows the first few numbers. The rest of the numbers can be calculated by taking the desired negative number and adding it to 256. Example: If you need to lower the Acceleration by 10, add -10 to 256 and enter 246.

Negative Number	Value to Enter	Negative Number	Value to Enter
-1	255	-11	245
-2	254	-12	244
-3	253	-13	243
-4	252	-14	242
-5	251	-15	241
-6	250	-16	240

-7	249	-17	239
-8	248	-18	238
-9	247	-19	237
-10	246	-20	236

ACCELERATION ADJUST

LOC:1022 02:00PM ACCEL ADJUST: _

This can be set to a number from 0 to 255.

DECELERATION ADJUST

LOC:1022 02:00PM DECEL ADJUST: _

This can be set to a number from 0 to 255.

CV PROGRAMMING (Option 2)

This option allows you to change *any* configuration variable in your decoder

ENTER CONFIGURATION VARIABLE NUMBER

PROG CV 02:00PM ENTER CV NUM: _

All configuration variables can be set while on the mainline. Especially useful is setting the start voltage (CV#2). Just pressing **ENTER** with inputting a number will exit from CV programming. Programming CV1, CV17 or CV18 is a special case that is covered under **Programming a Loco Address on the Mainline** below.

ENTER THE VALUE

PROG CV 02:00PM ENTER VALUE: _

If a configuration variable number was entered in the previous screen the value to be input should be entered here.

SET DECODER CONFIGURATION (option 3)

```
SET CFG? 02:00PM
ENTER=NO 1=YES:_
```

Press **ENTER** to bypass the setting of the configuration variables. The decoder configuration register setting pertaining to normal loco operation are provided below with screen prompts for your assistance.

Press **1** to reach the screens to set the configuration variables.

DIRECTION BIT - NORMAL OR REVERSE

```
DIR BIT? 02:00PM
ENTER=NORM 1=REV
```

Press **ENTER** for decoder operation in the normal direction or press **1** to switch the direction of operation of the loco.

SPEED STEPS - 28 OR 14

```
SPEED 02:00PM
ENTER=28 1=14 _
```

Press **ENTER** for all newer 28 step decoders. If the decoder is an early 14 step decoder then press **1**. (all decoders made since 1997 support 28 speeds)

DC MODE

```
DC MODE 02:00PM
ENTER=NO 1=YES _
```

Press **ENTER** to turn DC operation mode off, press **1** to turn DC mode on. We recommend leaving DC mode off for most layouts. This is to prevent all you locomotives from taking off at once in case of a failure in your power station or someone accidentally connecting the track to a DC power supply (it happens more often than you might think).

ADV ACK

```
ADV ACK? 02:00PM
```

ENTER=NO 1=YES _

Press **ENTER** to turn Advanced Acknowledge mode off, press **1** to turn Advanced Acknowledge mode on.

NOTE: advanced acknowledgment is not operational in any decoders at this time as the NMRA has not defined how it is to work.

SPEED TABLE SELECTION

SPEED TBL 02:00PM
ENTER=STD 1=ALT_

If the Standard Speed Table is to be used, press **ENTER**. If the Alternate (uploadable) Speed Table in the decoder is to be used, press **1**.

ADDRESS TO BE USED

ADDRESS 02:00PM
ENTER=S 1=LONG:_

The short address is used when operating on DCC systems that do not use long addresses. If you are going to take your loco to a friend's layout and he has a Lenz, Digitrax, or Arnold system, you will need to set this prior to packing.

PROGRAMMING A LOCO ADDRESS ON THE MAINLINE

Select Option #2 (CV) from the PROGRAM ON THE MAIN screen below

LOC:1022 02:00PM
1=CON 2=CV 3=CFG

ENTER CV NUMBER FOR THE ADDRESS

PROG CV 02:00PM
ENTER CV NUM:_

If you are using the short address (CV1 is active) you can program CV17 (the long address is stored in CV17). In a similar manner if you are currently using the long address (CV17 is active) you can program CV1 (where the short address is stored). If you enter 1, the prompt will change to **SHORT ADDR:** and if you enter 17 the prompt will change to **LONG ADDR:.** If the address is in use the

display will show CAN NOT PROG ADDR IN USE. Put in the desired address and press **ENTER**.

ACTIVATE 02:00PM ENTER=YES 1=NO

After entering the address you be asked if you want to activate this address. If you press **ENTER** the address will be activated and your cab will be set to control the new address. If you press **1** the new address not be activated but will remain able to be activated at a later time if you wish through option #3 (CFG) programming.

ASSIGNING A LOCO TO A CAB

This selection passes a loco from one cab to another. This is especially useful when the other operator is a novice or has a Basic Cab. The locomotive/consist is passed to the assigned cab and the locomotive/consist controlled the other cab is passed back to the original cab. In effect the locomotives controlled by the cab are “swapped”. This way you will not accidentally ‘lose’ a locomotive in the system.

ASSIGN THE LOCO

ASSIGN 02:00PM WHICH LOCO: _

Enter the loco/consist number then press **ENTER**.

ASSIGN THE CAB

LOC:1234 02:00PM TO WHICH CAB? _

Enter the Cab number then press **ENTER**.

This operation is also very useful to transfer old style consists to a smaller cab without the capability of setting up consists.

SET THE SYSTEM CLOCK

This allows the operator to start/stop the clock, set it, choose 12 or 24 hour operation, or change the fast clock ratio.

STOPPING THE CLOCK

```
STOP? 02:00PM
ENTER=NO 1=STOP
```

Press **1** to stop the clock, press **ENTER** to leave the clock running and continue with clock programming. If the clock is stopped, re-entering **SET THE SYSTEM CLOCK** will let you re-start it.

SETTING 12 or 24 HOUR MODE

```
SET TIME 02:00PM
1=12HR 2=24HR _
```

Press **1** for 12 hour mode, press **ENTER** for 24 hour mode.

ENTERING THE HOUR

```
SET TIME 02:00PM
ENTER HOURS: _
```

Enter the starting hour. For times in the A.M. use 0 to 11. For times in the P.M. use 12 to 23. Press **ENTER**.

ENTERING THE MINUTE

```
SET TIME 02:00PM
ENTER MINUTES:_
```

Enter the starting minute. Use 0 through 59. Press **ENTER**.

ENTERING THE RATIO

```
SET TIME 02:00PM
ENTER RATIO: _
```

Enter the ratio that the clock should run at with 1 being the normal speed. The ratio can be any number from 1/1 to 25/1. Press **ENTER**.

STARTING THE CLOCK

```
START? 02:00PM
```

ENTER=NO 1=START

If the clock was stopped, entering SET THE SYSTEM CLOCK will display this screen to let you start (or restart) the clock. Press **1** to start the clock, press **ENTER** to leave the clock stopped and continue with clock programming (see above).

USE PROGRAM TRACK

Various locomotive operating parameters are stored in decoders. These storage locations are called Configuration Variables (CVs). There is usually a CV for each programmable parameter. The PH-Pro allows you to change any or all of the configuration variables in the loco, including the address. These variables will remain as programmed until the you change them.

When programming your first few decoders make sure that you go through *all* of the standard programming steps. This assures that the decoder configuration (CFG) is set correctly. The **most common mistake** is setting the long address and not activating it in the CFG section while using the programming track. The programming track does not supply enough power to run your locomotive. It will run only on the main track.

SELECTING PROGRAMMING METHOD

PROG TRK 02:00PM
1=STD 2=CV 3=REG

This screen allows the user to select the method of programming to suit the decoder you are using. You can select between “paged” programming (the most common form of decoder programming) and “register” programming (only MRC currently uses this method). Press **1** to use standard “paged” programming to set the most common decoder parameters, press **2** to program any individual CV (via paged programming), and press **3** to use the register mode programming. Press **ENTER** to see two more programming options. Selection **4** will reset your NCE based decoders back to original factory settings. Option **5** can be used quickly upload one of nine factory designed speed tables into your decoder. If you decide to use one of these speed tables be sure to enable the alternate speed table in the CFG CV (CV29).

STANDARD PROGRAMMING (Option 1)

The PH-Pro used the NMRA recommended “PAGED” programming as its Standard programming method.

DECODER MANUFACTURER

```
MAIN OFF 02:00PM
MANUFACTURER:011
```

Returns the number of the manufacture of the decoder. All NCE™ Decoders respond with 11

DECODER VERSION

```
MAIN OFF 02:00PM
DECODER VER: 018
```

Displays the software version in the decoder.

```
MAIN OFF 02:00PM
CAN NOT READ CV
```

You will not see this screen unless there is a problem reading the decoder. It means the decoder is either not receiving programming commands (wiring error?) or it is not understanding them (bad decoder?). It could also mean that the programming track is not connected (it happens... really).

ENTERING THE SHORT ADDRESS

```
MAIN OFF 02:00PM
SHORT ADDR:
```

The short address is available for using our decoders on layouts using short addresses. The address should follow their recommended practice of using the last two digits of the loco's number. This will accept a number in the range of 1 to 127. See recommendation for short addresses below.

We recommend that if a long address is used, leave the short address at 3. This has two advantages. One, if the long address is forgotten, the short address is always 3. Two, the consist addresses share the same 1 to 127 address range available to the short addresses. Using the same address for the Consist as an existing loco with it's short address will cause un-predictable results.

ENTERING THE LONG ADDRESS

```
MAIN OFF 02:00PM
```

LONG ADDR:

Any number from 0 through 9999 can be used. You need to distinguish advanced decoders from the older models when assigning them a number below 128 by entering a zero as the first character. You want to remember though that the consist addresses are limited to 1 to 127, so it may be advantageous to not enter a long address below 128.

Example: Old decoder = 64 Advanced = 064

We recommend that if a long address is used, leave the short address at 3. This has two advantages. One, if the long address is forgotten, the short address is always 3. Two, the consist addresses share the 1 to 127 address range available to the short addresses. Using the same address for the Consist as an existing loco with it's short address will cause un-predictable results.

ACCELERATION

MAIN OFF 02:00PM
ACCELERATION:

This can be set to any number from 0 to 255.

DECELERATION

MAIN OFF 02:00PM
DECELERATION:

This can be set to any number from 0 to 255.

START VOLTAGE

MAIN OFF 02:00PM
START VOLTAGE:

This can be set from 0 to 255. Each unit represents roughly 1/100 of full voltage.

SETTING THE DECODER CONFIGURATION (CFG)

SET CFG? 02:00PM
ENTER=NO 1=YES:

The configuration variables pertaining to normal loco operation are provided below with screen prompts for your assistance. Other variables that are not

addressed via STD (also called “paged”) programming below do not normally need to be changed. Press **1** to reach the screens to set the configuration variables.

NOTE: Do Not press enter here if you are programming the Decoder for the first time. The following screens are very important to complete the Decoder programming (such as the long/short address selection).

SPEED STEPS - 28 OR 14

SPEED 02:00PM ENTER=28 1=14

Press **ENTER** to keep 28 speed mode selected or **1** to use 14 speed step mode in the decoder.

DC MODE

DC MODE 02:00PM ENTER=NO 1=YES _

Press **ENTER** to turn DC mode off, press **1** to turn DC mode on.

SPEED TABLE SELECTION

SPEED TBL02:00PM ENTER=SDT 1=ALT:

Press **ENTER** to use the standard speed table. If the alternate speed table is to be used press **1**. Before selecting the Alternate Speed Table please read the explanation regarding programming the alternate speed table.

LONG/SHORT ADDRESS SELECTION

ADDRESS 02:00PM ENTER=S 1=LONG:

Press **ENTER** to activate the short address, press **1** to activate the long address.

CV PROGRAMMING (option 2)

This option allows you to any CV in a decoder (from CV1-CV999) using the NMRA “PAGED” mode of programming.

ENTER CV NUMBER

PROG CV 02:00PM ENTER CV NUM:_

All configuration variables are detailed in the Appendix. Those that are normally used are set through screen inputs such as speed tables, start voltage, acceleration and deceleration settings. This screen should normally be skipped by pressing **ENTER**.

ENTER CV VALUE

PROG CV 02:00PM ENTER VALUE: _

If a configuration variable number was entered in the previous screen the input value would be entered here.

PROGRAMMING CV 29

You can program CV 29 (the CFG variable) directly by building up the value from each of the individual values. Start with '0' and add each value shown below, and program CV 29 with the total.

- 1 Loco Direction, 0= normal operation, 1 =reversed direction
- 2 28 speed step mode, 0=14 speed step, 2 = 28 speed step mode
- 4 0 = DC operation (analog) mode off, 4 = DC mode on
- 16 0 = Use factory speed table, 16 = use alternate speed table
- 32 0 = Use short address (CV1), 32 = Use long address (CV17/18)

REGISTER PROGRAMMING (Option 3)

The programming section is included to make setting of MRC and old Lenz Decoders easier. Refer to the document that is included with the Decoder for register information.

ENTER THE REGISTER TO PROGRAM

PROG TRK 02:00PM REGISTER? _

Enter the register number and press **ENTER**. The current value will be read from the Decoder and displayed.

ENTER REGISTER VALUE

PROG CV 02:00PM REGISTER 2= _

Enter the value you want to program into the register you selected above and press **ENTER**.

RESET DECODERS TO FACTORY VALUES (Option 4)

The programming section is included to allow the user to set *all* of registers of the Decoder to the values that were programmed into it at the factory.

FACTORY REPROGRAM

FACTORY 02:00PM REPROGRAM? 1=YES

Press **1** to enter Factory Reprogram mode. This will reprogram NCE decoders (and most others) to their original factory values.

FACTORY 02:00PM PROGRAMMING: 001

Each register will be programmed to the factory defaults. As each register (CV) is programmed the CV number is displayed.

SPEED TABLE PROGRAMMING (option 5)

The programming section is included to allow the user to quickly program the Decoder with one of several speed tables.

ENTER 02:00PM SPEED TABLE NUM:

Press **0 - 9** to enter one of the nine speed tables. Below is a listing of the pre-defined speed tables applicable to NCE decoders. You will need to activate the speed alternate speed table (SET CFG option) in the decoder configuration register to get the table to work.

Table Number	Frequency of motor drive
1	30 Hz

2	40 Hz
3	50 Hz
4	60Hz
5	70 Hz
6	80 Hz
7	90 Hz
8	100 Hz
9	130 Hz
0	180 Hz

SETUP COMMAND STATION

This allows the operator to view the Command Station's version number and set various parameters. If you press "28882" at the "SET CMD STATION" prompt the command station will be reset to all original factory settings.

DISPLAY SOFTWARE VERSION AND DATE

VERSION: 02:00PM THU APR 08 1999

This screen is important for when the time comes to call or write about a question or a problem.

The following screens are in place should a need arise to change any of the factory settings. There is probably no reason to ever change these settings. If you get thing REALLY messed up you can reset the system to original factory settings (see paragraph above).

NUMBER OF STOP PACKETS

NUMBER 02:00PM OF STOP PKTS 000

This adjusts the number of packets sent when a stop command is sent to the Loco. If set to zero all speed 0 commands will continue to be circulated for every locomotive that has been controlled (but now is stopped) since the start of the operating session. If you have a large layout or operate more than about 40 different locomotives in a operating session we recommend setting this to a value of

about 15. This will automatically purge non-necessary speed 0 commands from being sent to the track increasing system response to throttle commands. Factory default is 0.

NUMBER OF TEMP PACKETS

NUMBER 02:00PM OF TEMP PKTS 005

This adjusts the number of Function control commands are sent when a Function control button is pressed. Factory default is 5

NUMBER OF ACCESSORY PACKETS

NUMBER 02:00PM OF ACC PKTS: 004

This adjusts the number of accessory control commands sent when an accessory is controlled. Factory default is 4.

NUMBER OF HORN LOOP

NUMBER 02:00PM OF HORN LOOP 001

This adjusts an internal command station parameter to optimize operation of the HORN button when used with DCC sound systems. ALWAYS leave this set to 1 if you have one command station

NUMBER OF PROGRAM PACKETS

NUMBER 02:00PM OF PROG PKTS: 04

This adjusts the number of commands sent when a programming a locomotive on the mainline. Factory default is 4.

TEST FOR LOCO IN USE

TEST FOR 02:00PM LOCO IN USE? YES

Press ENTER to see the next screen

If set to YES, a warning will be issued to the operator if a Loco is selected that is in use by someone else. If set to NO, no warning is issued.

TEST? 02:00PM 1=YES 2=NO

We prefer No.

LAST CAB TO PROGRAM ON MAIN

LAST CAB 02:00PM TO PRG ON MAIN00

This sets the highest Cab address that will be able to access Programming on the Main. Cabs above this setting will skip the PROGRAM ON MAIN menu selection. 00 = all Cabs have access. This and the following command station setup parameters are useful for clubs that have a lot of members but wanting to limit which of those members can access various system options during an operating session.

LAST CAB TO ASSIGN LOCO

LAST CAB 02:00PM TO ASSIGN LOCO00

This sets the highest Cab address that will be able to access the Assign Loco to Cab menu. Cabs above this setting will skip the ASSIGN LOCO->CAB menu selection. 00 = all Cabs have access.

LAST CAB TO SET CLOCK

LAST CAB 02:00PM TO SET CLOCK 00

This sets the highest Cab address that will be able to access the Set Clock menu. Cabs above this setting will skip the SET SYSTEM CLOCK menu selection. 00 = all Cabs have access.

LAST CAB TO USE PROGRAM TRACK

LAST CAB 02:00PM

TO USE PRG TRK00

This sets the highest Cab address that will be able to access the Programming Track. Cabs above this setting will skip the USE PROGRAM TRK menu selection. 00 = all Cabs.

LAST CAB TO SET COMMAND STATION

LAST CAB 02:00PM
TO SET CMD STA00

This sets the highest Cab address that will be able to Set Up the Command Station. Cabs above this setting will skip the SET CMD STATION menu selection. 00 = all Cabs.

LAST CAB TO SET ITSELF

LAST CAB 02:00PM
TO SET ITSELF 00

This sets the highest Cab address that will be able to access the Set Cab Parameters menu. Cabs above this setting will skip the SET CAB PARAMS menu selection. 00 = all Cabs have access.

LAST CAB TO PROGRAM ACCESSORIES

LAST CAB 02:00PM
TO PROGRAM ACC00

This sets the highest Cab address that will be able to Program Accessories. Cabs above this setting will skip the PROG ACCESSORIES menu selection. 00 = all Cabs.

LAST CAB TO PROGRAM MACROS

LAST CAB 02:00PM
TO PROG MACROS00

This sets the highest Cab address that will be able to Program macros. Cabs above this setting will skip the PROGRAM MACROS menu selection. 00 = all Cabs.

FUNCTION REPEAT RATE

```
FUNCTION 02:00PM
REPEAT RATE: _
```

This parameter controls the rate at which Function Group One (F0-F4) commands are repeated on the rails after the "normal" number (TEMP PKTS... see TEMP PKTS above) of commands are sent. When set to zero the function commands are never repeated. If non-zero, Function Group One commands are generated and sent out over the rails for the current active locomotive on each cab. The rate of sending these packets is approximately $.004 * n$ seconds (where $n = \text{value}$). Example: $n = 250$ refreshes all function group one packets about once each second. This should be only be used when using Decoders (many Digitrax decoders) which do not remember the Function status after a power interruption. All NCE, LENZ and SYS1 Decoders remember their Function status, and therefore do not need this set to anything other than zero. It is recommended that this value be set above 200, numbers below 100 will not be accepted by the command station.

SETTING THE CAB PARAMETERS

This allows the operator to set the Cab Address, the control method (yard or regular), ballistic tracking of the cab and which functions are activated when the Horn/Whistle and Bell keys are pressed.

NUMBER OF RECALLS

```
NUMBER 02:00PM
OF RECALLS: 02
```

This adjusts the number of recall "slots" that are cycled through when the **RECALL** key is pressed. Enter a number of Recalls from 1 - 6 and press **ENTER**. This can be set differently for each Cab. (factory default is 2)

CLEAR RECALLS

```
CLEAR 02:00PM
RECALLS 1=YES:
```

Clears the current **RECALL** storage. Press **1** to clear out the **RECALL** slots, press **ENTER** to leave them alone.

SETTING THE CAB ADDRESS

```
CAB ADDR 02:00PM
ENTER=NO 1=SET
```

Press **ENTER** to bypass or **1** to set address.

NOTE: The following set of screens may be different depending on the model of the Cab. These screens are for the PROCAB. If you have a different cab consult the instructions that come with it.

CAB ADDRESS

Upon selecting the SET CAB ADDR mode the cab enters its own *internal set up procedure*. This procedure varies from cab to cab depending upon the capabilities of that cab.

```
CAB ADDRESS : 02
PROCAB VER 1.3
```

The Cab address can be any number from 1 through 63 (although we recommend using 2 as the lowest Cab number). **DO NOT SET TO 0 OR 00.** If the Cab is set to 0 or 00 it will lock-up, to correct this pull the Cab jack out of the Cab Bus Panel and then with the **SELECT LOCO** key held down plug it back in. Now you can correct the Cab address. ALWAYS ENTER 2 DIGITS when setting the cab address (followed by the ENTER key).

SEE THE CAB OPERATION MANUAL FOR:

- Selecting yard or regular mode
- Ballistic tracking rate
- Speaker on time

This ends the Cab specific setup screens.

ASSIGNING THE HORN/WHISTLE FUNCTION

```
ASSIGN 02:00PM
HORN TO FUNC: 2
```

Enter the function number that should be activated when the Horn/Whistle key is pressed. The NMRA suggests using 2, however any function number may be used.

ASSIGNING THE BELL FUNCTION

ASSIGN 02:00PM
BELL TO FUNC: 3

Enter the function number that should be activated when the Bell key is pressed. We Recommend using 1, however any function number may be used. Soundtraxx **Diesel** decoders use Function #1 for control of the Bell. Soundtraxx **Steam** decoders use Function #3 for the Bell. The steam decoders can have the bell “re-mapped” to Function #1 (Diesel decoders can not re-map the bell to Function #3).

PROGRAM ACCESSORY DECODERS ON THE MAIN

This allows the operator to set Accessory Decoder CV while they are connected to the Track (Accessory programming on the Main).

ENTER THE ACCESSORY ADDRESS

PROG ACC 02:00PM ACC. ADDR: _

Enter the Accessory Decoder address and press **ENTER**.

ENTER THE CV NUMBER

PROG ACC 02:00PM ENTER CV NUM:_

Enter the CV number that you want to program and press **ENTER**.

ENTER THE CV VALUE

PROG ACC 02:00PM ENTER VALUE: _

Enter the value you want in the CV and press **ENTER**.

PROGRAM MACROS

This allows the operator to program Macros (switch lists).

SELECT MACRO PROGRAM OR REVIEW

```
MACRO: 02:00PM
1=PROG 2=REVIEW
```

Press **1** to program a Macro or press **2** to review a programmed Macro. If **1** is pressed the following screen is displayed.

ENTER THE MACRO NUMBER

```
MACRO: 02:00PM
MACRO NUMBER: _
```

Enter the Macro number that you want to program (0-199), and press **ENTER**.

ENTER THE ACCESSORY ADDRESS

```
MAC: 000 02:00PM
ACCESSORY #: _
```

Enter the Accessory Address that you want to control, and press **ENTER**.

SELECT THE ACCESSORY OUTPUT

```
MAC: 000 02:00PM
ACC: 001 1=N 2=R
```

Press **1** for Normal or **2** for Route.

The above two screen will repeat up to 10 times to allow you to up to enter 10 accessories. After 10 accessories have been entered the SELECT MACRO PROGRAM OR REVIEW screen will be displayed. If you want to enter less than 10 accessories, leave the accessory # blank (just press **ENTER**).

If **2** is pressed on the SELECT MACRO PROGRAM OR REVIEW screen, the following screen is displayed.

ENTER THE REVIEW MACRO NUMBER

```
REVIEW: 02:00PM  
MACRO NUMBER:_
```

Enter the Macro number that you want to review (0-199), and press **ENTER**.

REVIEW MACRO

```
MAC: 000 02:00PM  
ACCESSORY: 001=N
```

The Accessory number and output will be shown. Press **ENTER** to see the next Accessory in the Macro. If there are no more Accessories in the Macro, the following screen will be displayed.

END OF MACRO REVIEW

```
MACRO: 02:00PM  
--END OF MACRO--
```

After **ENTER** is pressed, the **SELECT MACRO PROGRAM OR REVIEW** screen will be displayed.

ASCII COMMAND SET

All commands use the ASCII character set and are terminated with a Carriage Return (Enter). The examples below do not show the Carriage Return. The formats show the data for each command and the number of digits required. The spaces in the command and the exact number of digits must be correct for the command to execute. When the command completes successfully, the command prompt "COMMAND:" will be returned, otherwise an error message will be returned.

A - ASSIGN LOCO TO CAB

This command will allow the computer to assign a loco to a Cab. This is useful when using a simple Cab with no display, or in a club situation to speed setup. You must pad the address to 4 characters, long address padded with zeros, short addresses padded with dashes.

Format:

A dddd cc - dddd = loco address, cc = Cab address (1-60).

Example:

A 3741 04 - Assign loco 3741 (long address) to Cab 4.

A ---3 02 - Assign loco 3 (short address) to Cab 2.

C - READ SCALE TIME

This command will return the current scale time.

Format:

C - no data required.

Example:

C - Return the scale time in the format
<HH:MM><AM/PM> <Ratio>
<0=12Hr/1=24Hr>.

COMMAND: C
08:01AM 10 1

C0 - STOP THE CLOCK

This command will stop the clock.

Format:

C0 - no data required.

Example:

C0 - Stop the Clock

C1 - START OR RESUME THE CLOCK

This command will start (resume) the clock.

Format:

C1 - no data required.

Example:

c1 - Start the Clock

CH - SET THE CLOCK HOURS

This command will set the hours of the clock.

Format:

CH dd - dd = hours.

Example:

CH 12 - Set the hours to 12.

CM - SET THE CLOCK MINUTES

This command will set the minutes of the clock.

Format:

CM dd - dd = minutes.

Example:

CM 30 - Set the minutes to 30.

CS - SET THE CLOCK RATIO

This command will set the ratio of the clock. NOTE: some ratios are not attainable due to round-off errors of binary division. For instance, if you set the ratio to 23 you will actually get 25.

Format:

CS dd - dd = ratio.

Example:

CS 12 - Set the ratio to 12 to 1.

D - DEQUEUE PACKET

This command will remove a DCC command, by loco number, from the main command queue. The main queue continuously sends the command until it is removed with this command.

Format:

D xx xx - xx xx = loco address in hex. The top two bits in the first byte are set to indicate a long address.

Example:

D c0 03 - Remove the loco #3 command (long address) from main queue.

D 00 03 - Remove the loco #3 command (short address) from main queue.

E - ENABLE MAIN TRACK

This command will enable the track voltage for normal operations.

Format:

E - Enable main track.

Example:

E - Enable main track.

F - DISPLAY MEMORY

This command will display a section of the Command Station's PROM in hex and ASCII. This is used mostly for diagnostic purposes.

Format:

F y xxxx - y = hex lines - 0 = 256d, xxxx = hex address.

Example:

F 6 0000 - Display 6 lines of memory from 0000h.

```
ADDR  0  1  2  3  4  5  6  7  8  9  A  B  C  D  E  F
0000  C3 99 00 20 28 43 29 20 31 39 39 34 20 4E 4F 52  ... (C)
1994 NOR
0010  54 48 20 43 4F 41 53 54 20 45 4E 47 20 FF FF FF  TH COAST
ENG ...
0020  FF FF FF FF FF FF FF FF  FF FF FF FF FF FF FF FF
.....
0030  FF FF FF FF FF FF FF FF  FF FF FF FF FF FF FF FF
.....
0040  7B 4C 7E 4C 81 4C 84 4C 87 4C 0A 4D B9 4C 17 4D
{L~L.L.L.L.M.L.M
0050  6E 4B 4F 4C FF FF FF FF  FF FF FF FF FF FF FF FF
nKOL.....
COMMAND:
```

I - STATUS OF AUXILLARY INPUT UNIT (AIU)

This command returns the status of an AIU. The first four digits are the most significant followed by least significant current input status. The next four digits are the most significant followed by least significant of the inputs that have changed since the last **I** command.

Format:

I cc - cc = Cab address (1-60).

Example:

I 8 - Read status of AIU at address 8.
00 01 00 01

K - KILL MAIN TRACK

This command will turn off the voltage to the mainline track. All trains on the mainline will stop. This will also clear all of the command queues.

Format:

K - no data required.

Example:

K - Kill main track.

LM - SPEED STEP MODE

This command will set the speed step mode. NOTE: This command does not tack effect until the next time a Cab selects the Loco. Issue a Assign Cab command to force it to take effect earlier.

Format:

LM dddd d - dddd the Loco address, d - speed step mode.
1=14, 2=28, and 3=128.

Example:

LM 1234 2 - Set Loco 1234 to speed step 28.

LR - RETURN THE CURRENT SPEED STEP MODE

This command will return the speed step mode for the Loco requested.

Format:

LR dddd - dddd the loco address.

Example:

LR 1234 - Return the speed step mode for Loco 1234.

M - PROGRAMMING MODE

This command will turn off the voltage to the main track, and go into programming mode. See **USE PROGRAM TRACK** on page 5-65 and **PROGRAMMING MODE COMMANDS** on page 6-90. All trains on the mainline will stop.

Format:

M - no data required.

Example:

M - Go to programming mode.

```
**** PROGRAMMING MODE - MAIN TRACK NOW DISCONNECTED ****  
COMMAND:
```

Q - QUEUE PACKET

This command will put a DCC command in the main command queue. The main queue continuously sends the command until it is removed with the **DEQUEUE PACKET** command or replaced with another command with the same loco address. The command should be constructed using the NMRA DCC standard documentation (the Yellow book). The checksum must be calculated and added to the end of the command. This was done to facilitate sending an incorrect checksum during new equipment development.

Format:

Q xx xx ... - xx = hex byte, these may be repeated as necessary up to six bytes (you must send your own checksum).

Example:

Q 03 47 44 - Put a command for loco #3, speed 6, forward direction, in main queue.

Q 03 40 43 - Put a command for loco #3, speed 0, forward direction, in main queue.

S - SEND PACKET

This command will put a DCC command in the temporary send queue. After the number of times to be repeated is finished, the command will be automatically removed from the queue. The command should be constructed using the NMRA DCC standard documentation (the Yellow book). The checksum must be calculated and added to the end of the command. This was

done to facilitate sending an incorrect checksum during new equipment development.

Format:

S Cyy xx ... - Cyy = the number of times to send in hex, xx = hex byte, these may be repeated as necessary up to six bytes (you must send your own checksum).

Example:

S C05 03 83 80 - Turn on functions 1 and 2 for loco #3 (note checksum 80. Send the command 5 times.

S C0A 80 98 18 - Turn on accessory number 1 (note checksum 18). Send the command 10 times.

V - VERSION NUMBER

This command will display the version number of the Command Station.

Format:

V - no data required

```
NCE Coroproration
COMMAND STATION
Thu Sept 11 09:10:54 1999
COMMAND:
```

W - WRITE MEMORY

This command will write to any memory location. NOTE: Use this with extreme caution. Improper use of this command may cause the Command Station to behave erratically.

Format:

W xxxx xx - xxxx = hex address, xx = hex data.

Example:

W 1000 10 - Set the memory location 1000H to 10H.

X - DISPLAY TEXT ON LINE 3

Y - DISPLAY TEXT ON LINE 4

This command will allow the computer to display a message on any Cab with a display. The operator can press ENTER to clear the message. Only uppercase characters are displayed, any lowercase characters are converted to uppercase.

The Cab's display can be thought of as having 4 lines, with only 2 of the lines showing at any one time. These commands write to lines 3 and 4 without disturbing lines 1 and 2. When these commands are received, the Cab switches to showing lines 3/4. When the operator presses ENTER, the Cab switches back to lines 1/2. Currently pressing EXPN will flip from lines 1/2 to lines 3/4, and back again.

Format:

X (or Y) cc 16chars - cc = Cab address (01-60), 16chars = 16 ASCII characters

Example:

X 02 PLEASE HOLD AT - Display message on Cab 2 (note that there are two spaces required after each of these lines to get the character count to 16)
 Y 02 UNION JUNCTION

Z - DISPLAY TEXT IN THE LOWER RIGHT CORNER

This command will allow the computer to display a message on any Cab with a display. The operator can press ENTER to clear the message. Only uppercase characters are displayed, any lowercase characters are converted to uppercase.

Format:

Z cc 8chars - cc = Cab address (01-60), 8chars = 8 ASCII characters

Example:

Z 02 PROCEED - Display message on Cab 2 (NOTE: a space is included preceding the message to separate it from the loco's speed.

H or ? - HELP

This command will display help for all of the available normal operations mode commands:

Format:

? - no data required

A dddd dd	Assign loco dddd to cab dd (decimal numbers)
LR dddd	Return speed and speed mode of loco dddd
LM dddd d	Set speed mode of loco dddd to d, 1=14, 2=28, 3=128)
NOTE:	Pad long loco address leading zeroes
NOTE:	Pad short loco address with leading dashes
C	Read scale time. Returns HH:MM RATIO 1 0
C0	Clock stop
C1	Clock resume (start)
CH dd	Set clock hours to dd (decimal)
CM dd	Set clock minutes to dd (decimal)

CR dd Set clock ratio to dd (decimal)
 D xx [xx] Dequeue packet (xx [xx] = loco address in hex) if it
 E Enable main track
 F y xxxx Display y lines of system memory at xxxxh
 I dd Inquire on status of Cab Bus Aux Input Unit dd (decim
 K Kill main track and it,s queues
 M Maintenance (programming) mode
 Q xx... Queue hex bytes (will replace any packet of same addr
 S Cyy xx... Send packet xx xx... Cyy times (hex bytes)
 V Return manufacturer, model, version of command static
 W xxxx xx Write memory location xxxx with xx
 X dd 16char Send 16 bytes to Cab dd (decimal) LCD line 3
 Y dd 16char Send 16 bytes to Cab dd (decimal) LCD line 4
 ? This help screen
 COMMAND:

PROGRAMMING MODE COMMANDS

R - READ CV

This command will allow the computer to read any CV in the loco on the programming track.

Format:

Rxxx - xxx = CV number

Example:

R001 - Read CV at location 1

```
COMMAND: r001
003 03h
COMMAND:
```

P - PROGRAM CV

This command will allow the computer to program any CV in the loco on the programming track.

Format:

Pxxx xxx - xxx = CV number, xxx = value

Example:

P001 003 - Program CV at location 1 with 3

X - EXIT PROGRAMMING MODE

This command will exit programming mode, and return to normal operations mode. The main track will be automatically enabled.

Format:

X - no data required

Example:

x - Exit program mode

```
COMMAND: **** RETURNING TO OPERATIONS MODE ****
```

H or ? - HELP

This command will display help for all of the available programming mode commands:

Format:

? - no data required

Example:

? - Exit program mode

**** COMMAND SUMMARY ****

Rxxx	Read CVxxx (0 = CV 256)
Pxxx xxx	Program CVxxx with decimal data xxx
Dxxx	Dump 10 CVs starting at xxx
Sx xxx	Program register x with decimal data xxx
Vx	Verify (read) register x
X	Exit programming mode
?	Help

NOTE: xxx = range 000 -> 255

NOTE: x = range 1 -> 8

V - READ REGISTER

This command will allow the computer to read a CV register in the loco on the programming track. This is for the new indexed mode Lenz decoder.

Register 1 = CV1 Short address

Register 2 = CV2 Start voltage

Register 3 = CV3 Acceleration

Register 4 = CV4 Deceleration

Register 5 = CV29 (Lenz index register)

Register 6 = error register (Lenz data register)

Register 7 = software version number

Register 8 = manufacturer number

Format:

Vx - x = Register number form 1 - 8.

Example:

v1 - Read register 1.

COMMAND: v1

003 03h

COMMAND:

S - WRITE REGISTER

This command will allow the computer to program a CV register in the loco on the programming track. This is for the new indexed mode Lenz decoder.

Register 1 = CV1 Short address

Register 2 = CV2 Start voltage
Register 3 = CV3 Acceleration
Register 4 = CV4 Deceleration
Register 5 = CV29 (Lenz index register)
Register 6 = error register (Lenz data register)
Register 7 = software version number
Register 8 = manufacturer number

Format:

Sx xxx - x = register number from 1 - 8, xxx = value.

Example:

S1 003 - Program register 1 with 3.

BINARY COMMAND SET (recommended)

The RS-232 port binary commands are designed to work in a computer friendly way.

Command format is: <cmd number> <data> <data> ...

Commands range from 0x80 to 0xBF

Commands and formats supported:

CMD FORMAT	DESCRIPTION	# OF BYTES RETURNED	POSSIBLE RESPONSES
0x80	NOP, dummy instruction	(1)	!
0x81 xxxx cc	assign loco xxxx to cab cc	(1)	!,1,2
0x82	read clock	(2)	<hours> <minutes>
0x83	Clock stop	(1)	!
0x84	Clock start	(1)	!
0x85 xx xx	Set clock hr/min	(1)	!,3
0x86 xx	Set clock 12/24 0=12 hr 1=24 hr	(1)	!,3
0x87 xx	Set clock ratio	(1)	!,3
0x88 xxxx	Dequeue packet by loco addr	(1)	!,1,3
0x89	Enable main trk, kill prog	(1)	!
0x8A cc	Return status of AIU cc	(4)	<current hi byte> <current lo byte> <change hi byte> <change lo byte>
0x8B	Kill main trk, enable prog	(1)	!
0x8C	Dummy instruction to get "!" followed 0x0D and 0x0A	(3)	! CR/LF
0x8D xxxx mm	Set speed mode of loco xxxx to mode mm, 1=14, 2=28, 3=128	(1)	!,1,3 <speed mode, 0 to 3>
0x8E aaaa nn <16 data bytes>	Write nn bytes, start at aaaa Must have 16 data bytes, pad them out to 16 if necessary	(1)	!,4
0x8F aaaa	Read 16 bytes, start at aaaa	(16)	16 bytes
0x90 cc xx...	Send 16 char message to Cab cc LCD line 3. xx = 16 ASCII char	(1)	!,2
0x91 cc xx...	Send 16 char message to Cab cc LCD line 4. xx = 16 ASCII char	(1)	!,2
0x92 cc xx...	Send 8 char message to Cab cc LCD line 2 right. xx = 8 char	(1)	!,2

0x93 ss <3 byte packet>	Queue 3 byte packet to TEMP_Q Send ss times	(1)	!
0x94 ss <4 byte packet>	Queue 4 byte packet to TEMP_Q Send ss times	(1)	!
0x95 ss <5 byte packet>	Queue 5 byte packet to TEMP_Q Send ss times	(1)	!
0x96 ss <6 byte packet>xx	Queue 6 byte packet to TEMP_Q Send ss times	(1)	!
0x97 aaaa xx	Write 1 byte to cmd sta RAM	(1)	!
0x98 aaaa xx xx	Write 2 bytes to cmd sta RAM	(1)	!
0x98 aaaa <4 data bytes>	Write 4 bytes to cmd sta RAM	(1)	!
0x98 aaaa <8 data bytes>	Write 8 bytes to cmd sta RAM	(1)	!
0x9B yy	Return status of AIU yy (short form of command 0x8A)	(2)	<current hi byte> <current lo byte>
0x9C xx	Execute macro number xx in the range of 0->199	(1)	! = success 0 = macro "empty" 3 = macro number
0x9D aaaa	Read 1 byte of RAM from aaaa	(1)	1 byte
0xA3 <3 byte packet>	Queue 3 byte packet to TRK_Q (replaces any packet with same address if it exists)	(1)	!,1
0xA4 <4 byte packet> 0xA4 xx xx...	Queue 4 byte packet to TRK_Q (replaces any packet with same address if it exists)	(1)	!,1
0xA5 <5 byte packet> 0xA5 xx xx...	Queue 5 byte packet to TRK_Q (replaces any packet with same address if it exists)	(1)	!,1

Commands 0x9D to 0xA2 and 0xA6 to 0xBF are not used and return '0'

Errors returned:

- '0'= command not supported
- '1'= loco address out of range
- '2'= cab address out of range
- '3'= data out of range
- '4'= byte count out of range
- '!'= command completed successfully

Assign a loco to a cab

Loco address for this command is always 2 bytes. The first byte is zero in the case of a short address. If the address is long then bits 6,7 of first byte must be set to 1

Format: 0x81 xxxx cc
 xxxx = loco address
 cc = cab number (0x01 to 0x3f)

Returns: ! = success
 1 = bad loco address
 2 = bad cab address

Read the clock

Format: 0x82

Returns 2 bytes: HOURS
 MINUTES

Stop the clock

Format: 0x83 Clock stop

Returns: ! = success

Start the clock

FORMAT: 0x84 Clock resume (start)

Returns: ! = success

Set the clock

Format: 0x85 hh mm Set clock hours, minutes

Returns: ! = success
 3 = hours or minutes data too large

Set the clock 12/24 hour format

Format: 0x86 xx Set clock 12/24 hours
 xx=0 means 12 hour clock
 xx=1 means 24 hour clock

Returns: ! = success
 3 = 12/24 format not 0 or 1

Set the speed mode of loco dddd.

The loco address for this command is always 2 bytes. The first byte is zero in the case of a short address. If the address is long then bits 6,7 of first byte must be set to 1.

Format: 0x8D xxxx mm
 xxxx = 8/14 bit address (short address 1st byte=0)
 (long address 1st byte bits 6,7 are set to 1)
 mm = mode 1=14spd, 2=28spd, 3=128spd

Returns: ! if success
 1 if bad loco address
 3 if bad speed mode, only 1,2 or 3 accepted

Write bytes to a command station RAM address

16 data bytes are always required by the command. Only the specified number will be written. You must "pad" out the command with extra bytes to meet the 16 byte requirement even if all are not to be written.

Format: "0x8E aaaa nn <16 data bytes>"
 aaaa= RAM address, high byte first
 nn = number of bytes to use

Returns: !,4

Return 16 bytes from a RAM address

Format: "0x8F aaaa "
 aaaa= RAM address, high byte first

Returns: 16 data bytes

Send a message LCD line 3 of a cab

The characters to be printed are NOT range checked. They must be in the range of 0x20 to 0x5F

Format: 0x90 cc <16 ASCII characters>
 cc = cab number (0-63)

Returns: ! for success
 2 bad cab address

Send a message LCD line 4 of a cab

The characters to be printed are NOT range checked. They must be in the range of 0x20 to 0x5F.

Format: 0x91 cc <16 ASCII characters>
 cc = cab number (0-63)

Returns: ! for success
 2 bad cab address

Send a message LCD the right hand side of line 2 of a cab.

The characters to be printed are NOT range checked. They must be in the range of 0x20 to 0x5F.

Format: 0x92 cc <8 ASCII characters>
 cc = cab number (0-63)

Returns: ! for success
 2 bad cab address

Put a 3 byte packet in the TEMP_Q.

Packet addresses are NOT verified so be careful! A "send times" of zero is OK... the packet will not be sent. If "send times" of 255 is requested it will be adjusted to 254, due to a system limitation. The packet checksum must be included with the packet data

Format: 0x93 <send times> <3 packet bytes>

Returns: ! = success

Put a 4 byte packet in the TEMP_Q.

Packet addresses are NOT verified so be careful! A "send times" of zero is OK... the packet will not be sent. If "send times" of 255 is requested it will be adjusted to 254, due to a system limitation. The packet checksum must be included with the packet data

Format: 0x94 <send times> <3 packet bytes>

Returns: ! = success

Put a 5 byte packet in the TEMP_Q.

Packet addresses are NOT verified so be careful! A "send times" of zero is OK... the packet will not be sent. If "send times" of 255 is requested it will be adjusted to 254, due to a system limitation. The packet checksum must be included with the packet data

Format: 0x95 <send times> <3 packet bytes>

Returns: ! = success

Put a 6 byte packet in the TEMP_Q.

Packet addresses are NOT verified so be careful! A "send times" of zero is OK... the packet will not be sent. If "send times" of 255 is requested it will be adjusted to 254, due to a system limitation. The packet checksum must be included with the packet data

Format: 0x96 <send times> <3 packet bytes>

Returns: ! = success

Put a 3 byte packet in the TRK_Q.

The TRK_Q is only for speed and direction commands to a loco. Do not send anything else as any other command will replace the existing speed command for that loco. TRK_Q is limited to loco addresses. The loco address is used for comparison to see if a packet should be replaced. The packet checksum must be included with the packet data

Format: 0xA3 <data> <data> <data>

Returns: ! = success
 1 = bad loco address

Put a 4 byte packet in the TRK_Q.

The TRK_Q is only for speed and direction commands to a loco. Do not send anything else as any other command will replace the existing speed command for that loco. TRK_Q is limited to loco addresses. The loco address is used for comparison to see if a packet should be replaced. The packet checksum must be included with the packet data

Format: 0xA4 <data> <data> <data>

Returns: ! = success
 1 = bad loco address

Put a 5 byte packet in the TRK_Q.

The TRK_Q is only for speed and direction commands to a loco. Do not send anything else as any other command will replace the existing speed command for that loco. TRK_Q is limited to loco addresses. The loco address is used for comparison to see if a packet should be replaced. The packet checksum must be included with the packet data

Format: 0xA5 <data> <data> <data>

Returns: ! = success
 1 = bad loco address

TROUBLE SHOOTING

- Locomotive was running yesterday but today it just sits there. The headlight and other functions are controllable but it won't run. This sometimes happens when you clear a consist but for some reason the decoder misses the command. Use the **DEL LOCO** button to "re-delete" the locomotive. Alternatively use programming on the main to set CV19 to 0 (same thing as clearing the consist).
- Loco acts strange: Sometimes decoders from some manufacturers will "get lost". To correct this tip the loco to one side for a second or two, raising the wheels off the track a bit. This will allow the decoder to reset itself. If this does not work reprogramming the decoder may be necessary.
- Loco's all stopped: Check for a fault light(s) on the Power Station(s). There are no breakers to cool down or reset or buttons to push. When the short is eliminated all loco's will resume their movement. If that was not the problem press **ENTER** because someone may have pressed the **E-STOP** three times by accident.
- Head Light goes on and off as I change speed: You are operating a loco with an older 14 step decoder in the 28 step mode and the head light is ON only in the even speed steps.
- The programmability of the decoders give the modeler a *lot* of flexibility. However, this can lead to some un-predictable results. Here are a few tips to get you out of some situations:

Loco won't respond

Check that the short/long bit is set correctly in the CFG variable (CV 29).

The loco might be in a consist. Press **DEL LOCO**, the locomotive number then **ENTER**.

Loco won't run on an analog (DC) layout.

Check that the DC mode bit is set in the CFG variable (CV 29).